



DIN

NAUE GmbH

Sondermaschinen - und Filterbau

Am Rotböhl 5
64331 Weiterstadt

Tel. 0 61 50 / 97 38 - 0
Fax. 0 61 50 / 70 18

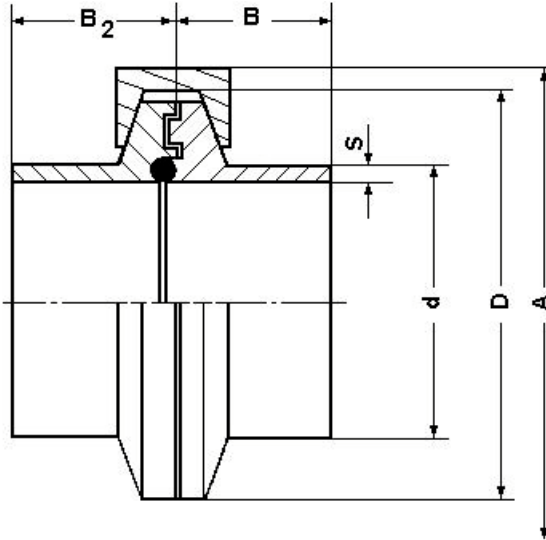

Aseptic-clamp union with two-sided seal face protection

Material	Clamp	1.4571 / 316 L
	Clamp with slot	1.4571 / 316 L
	Clamping ring	A2

Above steel qualities are available ex stock. Other steel qualities such as 316L and other dimensions are available upon request.

STANDARD-Design for manual welding

DN	d x s	D Ø	A	B	Bar	O-ring	Dimension clamping ring	Part n°
10	12,0 x 1,0	50,4	60	20	30	10,5 x 2,5	1,5	05-17003
15	18,0 x 1,5	50,4	60	20	30	15,0 x 3,0	1,5	05-17005
20	22,0 x 1,5	50,4	60	20	30	20,0 x 3,0	1,5	05-17006
25	28,0 x 1,5	50,4	60	20	30	25,0 x 3,0	1,5	05-17007
32	34,0 x 1,5	50,4	60	20	30	30,0 x 3,0	2,0	05-17008
40	40,0 x 1,5	64,0	74	20	30	39,0 x 3,0	2,0	05-17009
50	52,0 x 1,5	77,4	88	20	25	50,0 x 3,0	2,5	05-17010
65	70,0 x 2,0	91,0	100	20	25	66,0 x 4,0	3,0	05-17011
80	85,0 x 2,0	106,0	115	20	25	81,0 x 4,0	3,5	05-17012
100	104,0 x 2,0	119,0	165	20	25	100,0 x 4,0	4,0	05-17013
125	129,0 x 2,0	154,0	166	25	10	125,0 x 4,0	5,5	05-17014
150	154,0 x 2,0	168,0	182	25	10	150,0 x 4,0	6,0	05-17015

UNIVERSAL-Long design for automatic welding

DN	d x s	D Ø	A	B	Bar	O-ring	Dimension clamping ring	Part n°
10	12,0 x 1,0	50,4	60	30	30	10,5 x 2,5	1,5	05-17027
15	18,0 x 1,5	50,4	60	30	30	15,0 x 3,0	1,5	05-17029
20	22,0 x 1,5	50,4	60	30	30	20,0 x 3,0	1,5	05-17030
25	28,0 x 1,5	50,4	60	30	30	25,0 x 3,0	1,5	05-17031
32	34,0 x 1,5	50,4	60	30	30	30,0 x 3,0	2,0	05-17032
40	40,0 x 1,5	64,0	74	30	30	39,0 x 3,0	2,0	05-17033
50	52,0 x 1,5	77,4	88	30	25	50,0 x 3,0	2,5	05-17034
65	70,0 x 2,0	91,0	100	30	25	66,0 x 4,0	3,0	05-17035
80	85,0 x 2,0	106,0	115	30	25	81,0 x 4,0	3,5	05-17036
100	104,0 x 2,0	119,0	133	30	25	100,0 x 4,0	4,0	05-17037
125	129,0 x 2,0	154,0	166	35	10	125,0 x 4,0	5,5	05-17038
150	154,0 x 2,0	168,0	182	35	10	150,0 x 4,0	6,0	05-17039

Dimensions/Part numbers are subject to change without notice









DIN

NAUE GmbH

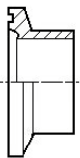
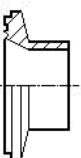
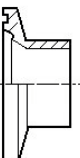
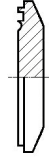
Sondermaschinen - und Filterbau

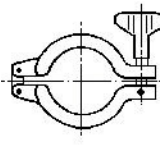
Am Rotböhl 5
64331 Weiterstadt

Tel. 0 61 50 / 97 38 - 0
Fax. 0 61 50 / 70 18

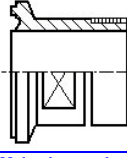
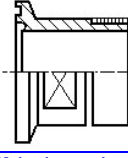
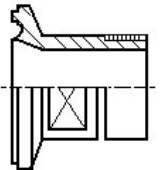
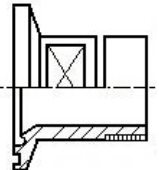
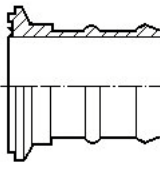
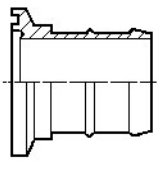
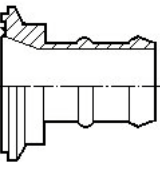
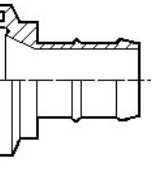
							
DN	Clamp DIN	Clamp with slot DIN	Clamp reduced DIN	Clamp with slot reduced DIN	Blind cap DIN	Blind cap with slot DIN	Clamping ring
10	05-17128	05-17103	05-17228	05-17253	05-17303	05-17353	05-00001
15	05-17130	05-17105	05-17230	05-17255	05-17305	05-17355	05-00001
20	05-17131	05-17106	05-17231	05-17256	05-17306	05-17356	05-00001
25	05-17132	05-17107	05-17232	05-17257	05-17307	05-17357	05-00001
32	05-17133	05-17108	05-17233	05-17258	05-17308	05-17358	05-00002
40	05-17134	05-17109	05-17234	05-17259	05-17309	05-17359	05-00002
50	05-17135	05-17110	05-17235	05-17260	05-17310	05-17360	05-00003
65	05-17136	05-17111	05-17236	05-17261	05-17311	05-17361	05-00004
80	05-17137	05-17112	05-17237	05-17262	05-17312	05-17362	05-00005
100	05-17138	05-17113	05-17238	05-17263	05-17313	05-17363	05-00006
150	05-17140	05-17115	05-17240	05-17265	05-17315	05-17365	05-00006
							
DN	Female clamp adapter DIN	Female clamp adapter with slot DIN	Female clamp adapter reduced DIN	Female clamp adapter reduced with slot DIN		Male clamp adapter DIN	Male clamp adapter with slot DIN
10	05-17378	05-17403	05-17428	05-17453		05-17828	05-17853
15	05-17380	05-17405	05-17430	05-17455		05-17830	05-17855
20	05-17381	05-17406	05-17431	05-17456		05-17831	05-17856
25	05-17382	05-17407	05-17432	05-17457		05-17832	05-17857
32	05-17383	05-17408	05-17433	05-17458		05-17833	05-17858
40	05-17384	05-17409	05-17434	05-17459		05-17834	05-17859
50	05-17385	05-17410	05-17435	05-17460		05-17835	05-17860
65	05-17386	05-17411	05-17436	05-17461		05-17836	05-17861
80	05-17387	05-17412	05-17437	05-17462		05-17837	05-17862
100	05-17388	05-17413	05-17438	05-17463		05-17838	05-17863
150	05-17390	05-17415	05-17440	05-17465		05-17840	05-17865
							
DN	Male clamp adapter DIN	Male clamp adapter with slot DIN	Clamp hose fitting DIN	Clamp hose fitting with slot DIN	Clamp hose fitting reduced DIN	Clamp hose fitting reduced with slot DIN	
10	05-17878	05-17903	05-17728	05-17703	05-17803	05-17778	
15	05-17880	05-17905	05-17730	05-17705	05-17805	05-17780	
20	05-17881	05-17906	05-17731	05-17706	05-17806	05-17781	
25	05-17882	05-17907	05-17732	05-17707	05-17807	05-17782	
32	05-17883	05-17908	05-17733	05-17708	05-17808	05-17783	
40	05-17884	05-17909	05-17734	05-17709	05-17809	05-17784	
50	05-17885	05-17910	05-17735	05-17710	05-17810	05-17785	
65	05-17886	05-17911	05-17736	05-17711	05-17811	05-17786	
80	05-17887	05-17912	05-17737	05-17712	05-17812	05-17787	
100	05-17888	05-17913	05-17738	05-17713	05-17813	05-17788	
150	05-17890	05-17915	05-17740	05-17715	05-17815	05-17790	

Dimensions/part numbers are subject to change without notice