



US
o.D. Tubina

NAUE GmbH

Sondermaschinen - und Filterbau

Am Rotböhl 5
64331 Weiterstadt

Tel. 0 61 50 / 97 38 - 0
Fax. 0 61 50 / 70 18

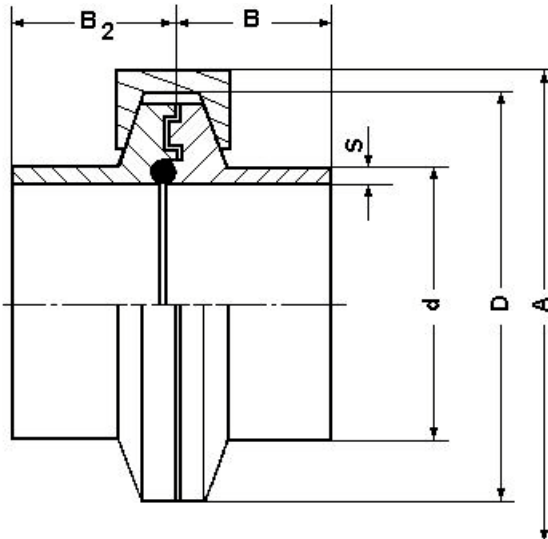

Aseptic-clamp union with two-sided seal face protection

Material	Clamp	1.4571 / 316 L
	Clamp with slot	1.4571 / 316 L
	Clamping ring	A2

Above steel qualities are available ex stock. Other steel qualities such as 316L and other dimensions are available upon request.

STANDARD-Design for manual welding

OD	d x s	D Ø	A	B	Bar	O-ring	Dimension clamping ring	Part n°
½	12,70 x 1,65	50,4	60		30	10,0 x 2,5	1,5	05-18003
¾	19,05 x 1,65	50,4	60		30	16,0 x 3,0	1,5	05-18005
1	25,40 x 1,65	50,4	60		30	22,0 x 3,0	1,5	05-18007
1 ½	38,10 x 1,65	64,0	74		30	36,0 x 3,0	2,0	05-18009
2	50,80 x 1,65	77,4	88		25	48,0 x 3,0	2,5	05-18010
2 ½	63,50 x 1,65	91,0	100		25	61,0 x 4,0	3,0	05-18011
3	76,20 x 1,65	106,0	115		25	74,0 x 4,0	3,5	05-18012
4	101,60 x 2,10	118,0	130		25	100,0 x 5,0	4,0	05-18013

ORBITAL-Long design for automatic welding

OD	d x s	D Ø	A	B	bar	O-ring	Dimension clamping ring	Part n°
½	12,70 x 1,65	50,4	60	20	30	10,0 x 2,5	1,5	05-18027
¾	19,05 x 1,65	50,4	60	20	30	16,0 x 3,0	1,5	05-18029
1	25,40 x 1,65	50,4	60	20	30	22,0 x 3,0	1,5	05-18031
1 ½	38,10 x 1,65	64,0	74	20	30	36,0 x 3,0	2,0	05-18033
2	50,80 x 1,65	77,4	88	20	25	48,0 x 3,0	2,5	05-18034
2 ½	63,50 x 1,65	91,0	100	20	25	61,0 x 4,0	3,0	05-18035
3	76,20 x 1,65	106,0	115	20	25	74,0 x 4,0	3,5	05-18036
4	101,60 x 2,10	118,0	130	20	25	100,0 x 5,0	4,0	05-18037

Dimensions/part numbers are subject to change without notice







US
o.D. Tubina

NAUE GmbH

Sondermaschinen - und Filterbau

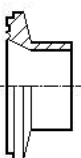
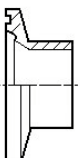
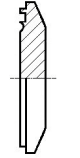
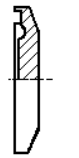
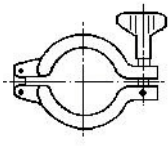
Am Rotböhl 5
64331 Weiterstadt

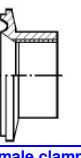
Tel. 0 61 50 / 97 38 - 0
Fax. 0 61 50 / 70 18

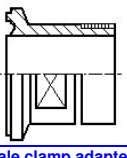
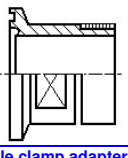
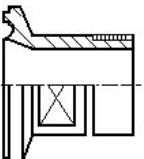
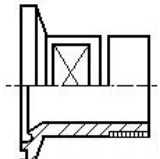
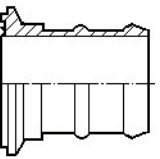
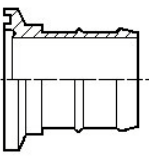
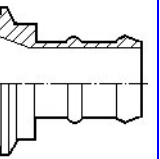
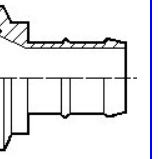
							
OD	Clamp US	Clamp with slot US	Clamp reduced US	Clamp with slot reduced US	Blind cap US	Blind cap with slot US	Clamping ring
$\frac{3}{8}$	05-18128	05-18103	05-18228	05-18253	05-18303	05-18353	05-00001
$\frac{1}{2}$	05-18130	05-18105	05-18230	05-18255	05-18305	05-18355	05-00001
$\frac{3}{4}$	05-18132	05-18107	05-18232	05-18257	05-18307	05-18357	05-00001
1	05-18134	05-18109	05-18234	05-18259	05-18309	05-18359	05-00002
1 1/2	05-18136	05-18111	05-18236	05-18261	05-18311	05-18361	05-00004
2	05-18138	05-18113	05-18238	05-18263	05-18313	05-18363	05-00006
2 1/2	05-18140	05-18115	05-18240	05-18265	05-18315	05-18365	05-00006
3	05-18142	05-18117	05-18242	05-18267	05-18317	05-18367	05-00006
4	05-18144	05-18119	05-18244	05-18269	05-18319	05-18369	05-00006
							
OD	Female clamp adapter US	Female clamp adapter with slot US	Female clamp adapter reduced US	Female clamp adapter reduced with slot US		Male clamp adapter US	Male clamp adapter with slot US
$\frac{3}{8}$	05-18378	05-18403	05-18428	05-18453		05-18828	05-18853
$\frac{1}{2}$	05-18380	05-18405	05-18430	05-18455		05-18830	05-18855
$\frac{3}{4}$	05-18382	05-18407	05-18432	05-18457		05-18832	05-18857
1	05-18384	05-18409	05-18434	05-18459		05-18834	05-18859
1 1/2	05-18386	05-18411	05-18436	05-18461		05-18836	05-18861
2	05-18388	05-18413	05-18438	05-18463		05-18838	05-18863
2 1/2	05-18390	05-18415	05-18440	05-18465		05-18840	05-18865
3	05-18392	05-18417	05-18442	05-18467		05-18842	05-18867
4	05-18394	05-18419	05-18444	05-18469		05-18844	05-18869
							
OD	Male clamp adapter US	Male clamp adapter with slot US	Clamp hose fitting US	Clamp hose fitting with slot US	Clamp hose fitting reduced US	Clamp hose fitting reduced with slot US	
$\frac{3}{8}$	05-18878	05-18903	05-18728	05-18703	05-18803	05-18778	
$\frac{1}{2}$	05-18880	05-18905	05-18730	05-18705	05-18805	05-18780	
$\frac{3}{4}$	05-18882	05-18907	05-18732	05-18707	05-18807	05-18782	
1	05-18884	05-18909	05-18734	05-18709	05-18809	05-18784	
1 1/2	05-18886	05-18911	05-18736	05-18711	05-18811	05-18786	
2	05-18888	05-18913	05-18738	05-18713	05-18813	05-18788	
2 1/2	05-18890	05-18915	05-18740	05-18715	05-18815	05-18790	
3	05-18892	05-18917	05-18742	05-18717	05-18817	05-18792	
4	05-18894	05-18919	05-18744	05-18719	05-18819	05-18794	

Dimensions/part numbers are subject to change without notice