



NAUE GmbH

Sondermaschinen - und Filterbau

Am Rotböll 5
64331 Weiterstadt
www.naue.de

Tel. 0 61 50 / 97 38 - 0
Fax. 0 61 50 / 70 18
Info@naue.de

Clamp union



**Massive clamp unions according to
ISO, DIN and US o. D. Tubing**



NAUE GmbH

Sondermaschinen - und Filterbau

Am Rotböhl 5
64331 Weiterstadt
www.naue.de

Tel. 0 61 50 / 97 38 - 0
Fax. 0 61 50 / 70 18
Info@naue.de

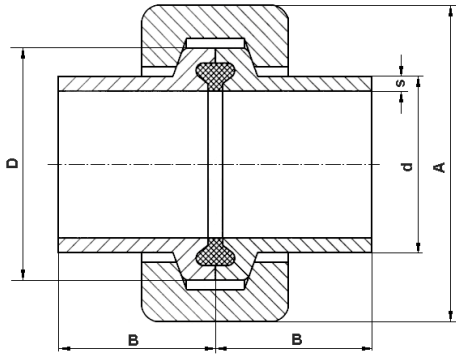

Mini - Clamp union

Material	Clamp	1.4404 / 316 L
	Clamp with slot	1.4404 / 316 L
	Clamping ring	A 2

Above steel qualities are available ex stock. Other steel qualities such as 316L and other dimensions are available upon request.

STANDARD-Design for manual welding

DN	D x s	D	A	B ₁	B ₂	L	bar	Part n°	ISO
6		25	32	15	15	27	30	05-34002	
8	10,2 x 1,6	25	32	15	15	27	30	05-34003	
10	13,5 x 1,6	25	32	15	15	27	30	05-34004	
12	17,2 x 1,6	25	32	15	15	27	30	05-34005	

4	6,0 x 1,0	25	32	15	15	27	30	05-35001	DIN
6	8,0 x 1,0	25	32	15	15	27	30	05-35002	
8	10,0 x 1,0	25	32	15	15	27	30	05-35003	
10	12,0 x 1,0	25	32	15	15	27	30	05-35004	
15	18,0 x 1,5	25	32	15	15	27	30	05-35005	

10	13,0 x 1,5	25	32	15	15	27	30	05-37004	DIN line 2
15	19,0 x 1,5	25	32	15	15	27	30	05-37005	

¼	6,35 x 1,22	25	32	15	15	27	30	05-36001	US o.D. Tubing
⅜	9,53 x 1,25	25	32	15	15	27	30	05-36002	
½	12,70 x 1,65	25	32	15	15	27	30	05-36003	
¾	19,50 x 1,65	25	32	15	15	27	30	05-36004	

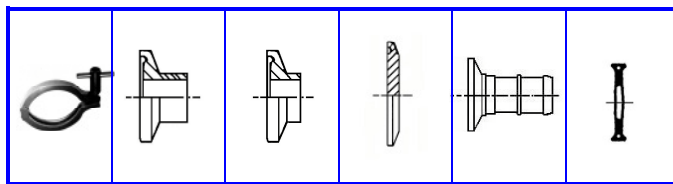

Clamping ring	Clamp orbital	Clamp standard	Blind cap	Hose nozzle	gasket	D	A	B	d x s	DN	ISO
05-27200	05-34151	05-34101	05-34225	05-34701	05-34276	25	32	15	8,0 x 1,0	6	
05-27200	05-34152	05-34102	05-34225	05-34702	05-34277	25	32	15	10,2 x 1,6	8	
05-27200	05-34153	05-34103	05-34225	05-34703	05-34278	25	32	15	13,5 x 1,6	10	
05-27200	05-34154	05-34104	05-34225	05-34704	05-34279	25	32	15	17,2 x 1,6	12	

05-27200	05-35150	05-35100	05-34225	05-35701	05-35275	25	32	15	6,0 x 1,0	4	DIN
05-27200	05-35151	05-35101	05-34225	05-35702	05-35276	25	32	15	8,0 x 1,0	6	
05-27200	05-35152	05-35102	05-34225	05-35703	05-35277	25	32	15	10,0 x 1,0	8	
05-27200	05-35153	05-35103	05-34225	05-35704	05-35278	25	32	15	12,0 x 1,0	10	
05-27200	05-35154	05-35104	05-34225	05-35705	05-35279	25	32	15	18,0 x 1,5	15	

05-27200	05-37153	05-37103	05-34225	05-37703	05-37278	25	32	15	13,0 x 1,5	10	DIN line 2
05-27200	05-37154	05-37104	05-34225	05-37704	05-37279	25	32	15	19,0 x 1,5	15	

05-27200	05-36150	05-36100	05-34225	05-37700	05-36275	25	32	15	6,35 x 1,22	¼	US o.D. Tubing
05-27200	05-36151	05-36101	05-34225	05-37701	05-36276	25	32	15	9,53 x 1,25	⅜	
05-27200	05-36152	05-36102	05-34225	05-37702	05-36277	25	32	15	12,70 x 1,65	½	
05-27200	05-36153	05-36103	05-34225	05-37704	05-36279	25	32	15	19,50 x 1,65	¾	

Dimensions/part numbers are subject to change without notice



NAUE GmbH

Sondermaschinen - und Filterbau

Am Rotböhl 5
64331 Weiterstadt
www.naue.de

Tel. 0 61 50 / 97 38 - 0
Fax. 0 61 50 / 70 18
Info@naue.de

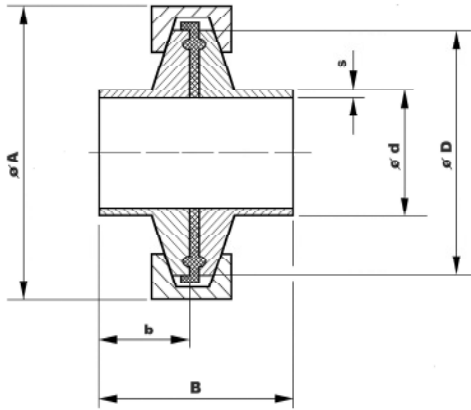

Clamp union

Material	Clamp	1.4404 / 316 L
	Clamp with slot	1.4404 / 316 L
	Clamping ring	A 2

Above steel qualities are available ex stock. Other steel qualities such as 316L and other dimensions are available upon request.

STANDARD-Design for manual welding

DN	D x s	D	A	b	B	Clamping ring dimension	Clamping ring part n°	Clamp union (complete) part n°
10	13,5 x 1,6	50	60	20	42	1 ½	05-00001	05-38003
12	17,2 x 1,6	50	60	20	42	1 ½	05-00001	05-38004
15	21,3 x 1,6	50	60	20	42	1 ½	05-00001	05-38005
20	26,9 x 1,6	50	60	20	42	1 ½	05-00001	05-38006
25	33,7 x 2,0	50	60	20	42	1 ½	05-00001	05-38007
32	42,4 x 2,0	64	74	20	42	2	05-00002	05-38008
40	48,3 x 2,0	64	74	20	42	2	05-00002	05-38009
50	60,3 x 2,6	91	100	20	42	3	05-00004	05-38010
65	76,0 x 2,6	91	100	20	42	3	05-00004	05-38011
80	88,9 x 2,6	106	115	20	42	3 ½	05-00005	05-38012
100	114,3 x 2,6	154	165	20	42	6	05-00007	05-38013
150	168,3 x 2,6	168	180	30	62	7	05-00008	05-38015

ISO

10	12,0 x 1,0	50	60	20	42	1 ½	05-00001	05-39003
15	18,0 x 1,5	50	60	20	42	1 ½	05-00001	05-39005
20	22,0 x 1,5	50	60	20	42	1 ½	05-00001	05-39006
25	28,0 x 1,5	50	60	20	42	1 ½	05-00001	05-39007
32	34,0 x 1,5	50	60	20	42	1 ½	05-00001	05-39008
40	40,0 x 1,5	50	60	20	42	1 ½	05-00001	05-39009
50	52,0 x 1,5	64	74	20	42	2	05-00002	05-39010
65	70,0 x 2,0	91	100	20	42	3	05-00004	05-39011
80	85,0 x 2,0	106	115	20	42	3 ½	05-00005	05-39012
100	104,0 x 2,0	119	130	20	42	4	05-00006	05-39013
125	129,0 x 2,0	154	165	25	52	6	05-00007	05-39014
150	154,0 x 2,0	168	180	30	62	7	05-00008	05-39015
200	204,0 x 2,0	220	230	35	72		05-00009	05-39016

DIN

½	12,70 x 1,65	50	60	20	42	1 ½	05-00001	05-40003
¾	19,05 x 1,65	50	60	20	42	1 ½	05-00001	05-40005
1	24,40 x 1,65	50	60	20	42	1 ½	05-00001	05-40007
1 ½	38,10 x 1,65	50	60	20	42	1 ½	05-00001	05-40009
2	50,80 x 1,65	64	74	20	42	2	05-00002	05-40010
2 ½	63,50 x 1,65	91	100	20	42	3	05-00004	05-40011
3	76,20 x 1,65	91	100	20	42	3	05-00004	05-40012
4	101,60 x 2,10	119	130	20	42	4	05-00006	05-40014

US o.D. Tubing

10	13,0 x 1,5	50	60	20	42	1 ½	05-00001	05-41003
15	19,0 x 1,5	50	60	20	42	1 ½	05-00001	05-41005
20	23,0 x 1,5	50	60	20	42	1 ½	05-00001	05-41006
25	29,0 x 1,5	50	60	20	42	1 ½	05-00001	05-41007
32	35,0 x 1,5	50	60	20	42	1 ½	05-00001	05-41008
40	41,0 x 1,5	50	60	20	42	1 ½	05-00001	05-41009
50	53,0 x 1,5	64	74	20	42	2	05-00002	05-41010

DIN line 2

Dimensions/part numbers are subject to change without notice



NAUE GmbH

Sondermaschinen - und Filterbau

Am Rotböhl 5
64331 Weiterstadt
www.naue.de

Tel. 0 61 50 / 97 38 – 0
Fax. 0 61 50 / 70 18
info@naue.de

ISO

DN	Welding clamp orbital	Welding clamp standard	Clamping ring	Blind cap	Gasket (silicone)	Gasket (EPDM)	Bend with clamps	Welding bend
10	05-38103	05-38128	05-00001	05-38303	05-38903	05-38928	05-38603	05-38628
12	05-38104	05-38129	05-00001	05-38303	05-38904	05-38929	05-38604	05-38629
15	05-38105	05-38130	05-00001	05-38303	05-38905	05-38930	05-38605	05-38630
20	05-38106	05-38131	05-00001	05-38303	05-38906	05-38931	05-38606	05-38631
25	05-38107	05-38132	05-00001	05-38303	05-38907	05-38932	05-38607	05-38632
32	05-38108	05-38133	05-00002	05-38304	05-38908	05-38933	05-38608	05-38633
40	05-38109	05-38134	05-00002	05-38304	05-38909	05-38934	05-38609	05-38634
50	05-38110	05-38135	05-00004	05-38305	05-38910	05-38935	05-38610	05-38635
65	05-38111	05-38136	05-00004	05-38305	05-38911	05-38936	05-38611	05-38636
80	05-38112	05-38137	05-00005	05-38306	05-38912	05-38937	05-38612	05-38637
100	05-38113	05-38138	05-00007	05-38307	05-38913	05-38938	05-38613	05-38638
125	05-38114	05-38139	05-00007	05-38308	05-38914	05-38939	05-38614	05-38639
150	05-38115	05-38140	05-00008	05-38309	05-38912	05-38940	05-38615	05-38640
DN	Clamp T-piece	Clamp cross-piece	Clamp hose fitting	Clamp hose fitting reduced	Clamping ring quick acting closure	Clamp for tap	Male clamp adapter	Conical clamp
10	05-38653	05-38678	05-38703	05-38753	05-38403	05-38453	05-38828	05-38463
12	05-38654	05-38679	05-38704	05-38754	05-38404	05-38454	05-38829	05-38464
15	05-38655	05-38680	05-38705	05-38755	05-38405	05-38455	05-38830	05-38465
20	05-38656	05-38681	05-38706	05-38756	05-38406	05-38456	05-38831	05-38466
25	05-38657	05-38682	05-38707	05-38757	05-38407	05-38457	05-38832	05-38467
32	05-38658	05-38683	05-38708	05-38758			05-38833	05-38468
40	05-38659	05-38684	05-38709	05-38759			05-38834	05-38469
50	05-38660	05-38685	05-38710	05-38760			05-38835	05-38470
65	05-38661	05-38686	05-38711	05-38761			05-38836	05-38471
80	05-38662	05-38687	05-38712	05-38762			05-38837	05-38472
100	05-38663	05-38688	05-38713	05-38763			05-38838	05-38473
125	05-38664	05-38689	05-38714	05-38764			05-38839	05-38474
150	05-38665	05-38690	05-38715	05-38765			05-38840	05-38475
DN	Clamp male piece	Female clamp adapter		Welding clamp reduced	Male clamp adapter reduced	Conical clamp reduced	Clamp male piece reduced	Female clamp adapter reduced
10	05-38478	05-38378		05-38153	05-38878	05-38503	05-38528	05-38428
12	05-38479	05-38379		05-38154	05-38879	05-38504	05-38529	05-38429
15	05-38480	05-38380		05-38155	05-38880	05-38505	05-38530	05-38430
20	05-38481	05-38381		05-38156	05-38881	05-38506	05-38531	05-38431
25	05-38482	05-38382		05-38157	05-38882	05-38507	05-38532	05-38432
32	05-38483	05-38383		05-38158	05-38883	05-38508	05-38533	05-38433
40	05-38484	05-38384		05-38159	05-38884	05-38509	05-38534	05-38434
50	05-38485	05-38385		05-38160	05-38885	05-38510	05-38535	05-38435
65	05-38486	05-38386		05-38161	05-38886	05-38511	05-38536	05-38436
80	05-38487	05-38387		05-38162	05-38887	05-38512	05-38537	05-38437
100	05-38488	05-38388		05-38163	05-38888	05-38513	05-38538	05-38438
125	05-38489	05-38389		05-38164	05-38889	05-38514	05-38539	05-38439
150	05-38490	05-38390		05-38165	05-38890	05-38515	05-38540	05-38440

Dimensions/part numbers are subject to change without notice



NAUE GmbH

Sondermaschinen - und Filterbau

Am Rotböhl 5
64331 Weiterstadt
www.naue.de

Tel. 0 61 50 / 97 38 – 0
Fax. 0 61 50 / 70 18
info@naue.de

DIN

DN	Welding clamp orbital	Welding clamp standard	Clamping ring	Blind cap	Gasket (silicone)	Gasket (EPDM)	Bend with clamps	Welding bend
10	05-39103	05-39128	05-00001	05-38303	05-39903	05-39928	05-39603	05-39628
15	05-39105	05-39130	05-00001	05-38303	05-39905	05-39930	05-39605	05-39630
20	05-39106	05-39131	05-00001	05-38303	05-39906	05-39931	05-39606	05-39631
25	05-39107	05-39132	05-00001	05-38303	05-39907	05-39932	05-39607	05-39632
32	05-39108	05-39133	05-00002	05-38304	05-39908	05-39933	05-39608	05-39633
40	05-39109	05-39134	05-00002	05-38304	05-39909	05-39934	05-39609	05-39634
50	05-39110	05-39135	05-00004	05-38305	05-39910	05-39935	05-39610	05-39635
65	05-39111	05-39136	05-00004	05-38305	05-39911	05-39936	05-39611	05-39636
80	05-39112	05-39137	05-00005	05-38306	05-39912	05-39937	05-39612	05-39637
100	05-39113	05-39138	05-00007	05-38307	05-39913	05-39938	05-39613	05-39638
125	05-39114	05-39139	05-00007	05-38308	05-39914	05-39939	05-39614	05-39639
150	05-39115	05-39140	05-00008	05-38309	05-39912	05-39940	05-39615	05-39640
DN	Clamp T-piece	Clamp cross-piece	Clamp hose fitting	Clamp hose fitting reduced	Clamping ring quick acting closure	Clamp for tap	Male clamp adapter	Conical clamp
10	05-39653	05-39678	05-39703	05-38753	05-39403	05-39453	05-39828	05-39463
15	05-39655	05-39680	05-39705	05-38755	05-39405	05-39455	05-39830	05-39465
20	05-39656	05-39681	05-39706	05-38756	05-39406	05-39456	05-39831	05-39466
25	05-39657	05-39682	05-39707	05-38757	05-39407	05-39457	05-39832	05-39467
32	05-39658	05-39683	05-39708	05-38758			05-39833	05-39468
40	05-39659	05-39684	05-39709	05-38759			05-39834	05-39469
50	05-39660	05-39685	05-39710	05-38760			05-39835	05-39470
65	05-39661	05-39686	05-39711	05-38761			05-39836	05-39471
80	05-39662	05-39687	05-39712	05-38762			05-39837	05-39472
100	05-39663	05-39688	05-39713	05-38763			05-39838	05-39473
125	05-39664	05-39689	05-39714	05-38764			05-39839	05-39474
150	05-39665	05-39690	05-39715	05-38765			05-39840	05-39475
DN	Clamp male piece	Female clamp adapter	Welding clamp reduced	Male clamp adapter reduced	Conical clamp reduced	Clamp male piece reduced	Female clamp adapter reduced	
10	05-39478	05-39378	05-39153	05-39878	05-39503	05-39528	05-39428	
15	05-39480	05-39380	05-39155	05-39880	05-39505	05-39530	05-39430	
20	05-39481	05-39381	05-39156	05-39881	05-39506	05-39531	05-39431	
25	05-39482	05-39382	05-39157	05-39882	05-39507	05-39532	05-39432	
32	05-39483	05-39383	05-39158	05-39883	05-39508	05-39533	05-39433	
40	05-39484	05-39384	05-39159	05-39884	05-39509	05-39534	05-39434	
50	05-39485	05-39385	05-39160	05-39885	05-39510	05-39535	05-39435	
65	05-39486	05-39386	05-39161	05-39886	05-39511	05-39536	05-39436	
80	05-39487	05-39387	05-39162	05-39887	05-39512	05-39537	05-39437	
100	05-39488	05-39388	05-39163	05-39888	05-39513	05-39538	05-39438	
125	05-39489	05-39389	05-39164	05-39889	05-39514	05-39539	05-39439	
150	05-39490	05-39390	05-39165	05-39890	05-39515	05-39540	05-39440	

Dimensions/part numbers are subject to change without notice









NAUE GmbH

Sondermaschinen - und Filterbau

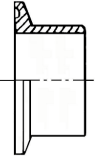
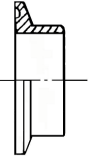
Am Rotböhl 5
64331 Weiterstadt
www.naue.de

Tel. 0 61 50 / 97 38 – 0
Fax. 0 61 50 / 70 18
info@naue.de

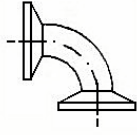
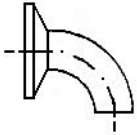
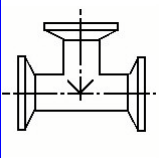
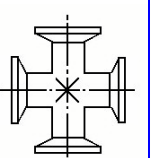
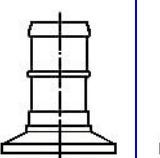
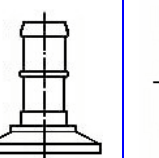
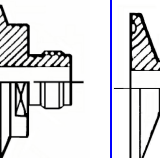
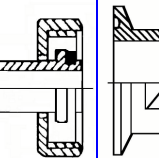
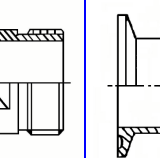
DIN line 2

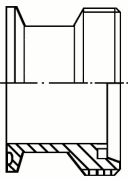
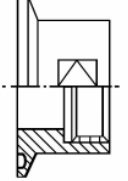
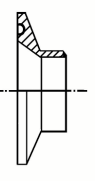
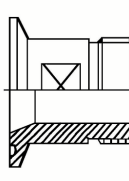
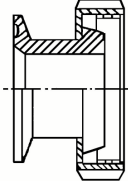
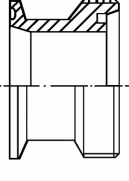
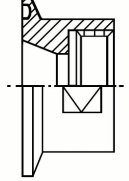
								
DN	Welding clamp orbital	Welding clamp standard	Clamping ring	Blind cap	Gasket (silicone)	Gasket (EPDM)	Bend with clamps	Welding bend
10	05-41103	05-41128	05-00001	05-38303	05-41903	05-41928	05-41603	05-41628
15	05-41105	05-41130	05-00001	05-38303	05-41905	05-41930	05-41605	05-41630
20	05-41106	05-41131	05-00001	05-38303	05-41906	05-41931	05-41606	05-41631
25	05-41107	05-41132	05-00001	05-38303	05-41907	05-41932	05-41607	05-41632
32	05-41108	05-41133	05-00002	05-38304	05-41908	05-41933	05-41608	05-41633
40	05-41109	05-41134	05-00002	05-38304	05-41909	05-41934	05-41609	05-41634
50	05-41110	05-41135	05-00004	05-38305	05-41910	05-41935	05-41610	05-41635
								
DN	Clamp T-piece	Clamp cross-piece	Clamp hose fitting	Clamp hose fitting reduced	Clamping ring quick acting closure	Clamp for tap	Male clamp adapter	Conical clamp
10	05-41653	05-41678	05-41703	05-41753	05-41403	05-41453	05-41828	05-41463
15	05-41655	05-41680	05-41705	05-41755	05-41405	05-41455	05-41830	05-41465
20	05-41656	05-41681	05-41706	05-41756	05-41406	05-41456	05-41831	05-41466
25	05-41657	05-41682	05-41707	05-41757	05-41407	05-41457	05-41832	05-41467
32	05-41658	05-41683	05-41708	05-41758			05-41833	05-41468
40	05-41659	05-41684	05-41709	05-41759			05-41834	05-41469
50	05-41660	05-41685	05-41710	05-41760			05-41835	05-41470
								
DN	Clamp male piece	Female clamp adapter		Welding clamp reduced	Male clamp adapter reduced	Conical clamp reduced	Clamp male piece reduced	Female clamp adapter reduced
10	05-41478	05-41378		05-41153	05-41878	05-41503	05-41528	05-41428
15	05-41480	05-41380		05-41155	05-41880	05-41505	05-41530	05-41430
20	05-41481	05-41381		05-41156	05-41881	05-41506	05-41531	05-41431
25	05-41482	05-41382		05-41157	05-41882	05-41507	05-41532	05-41432
32	05-41483	05-41383		05-41158	05-41883	05-41508	05-41533	05-41433
40	05-41484	05-41384		05-41159	05-41884	05-41509	05-41534	05-41434
50	05-41485	05-41385		05-41160	05-41885	05-41510	05-41535	05-41435

Dimensions/part numbers are subject to change without notice

