



ISO

NAUE GmbH

Sondermaschinen - und Filterbau

Am Rotböhl 5
64331 Weiterstadt

Tel. 0 61 50 / 97 38 - 0
Fax. 0 61 50 / 70 18

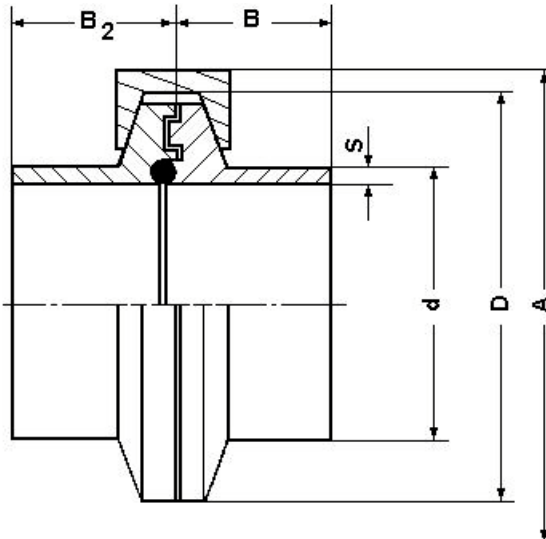

Aseptic clamp union with two-sided seal face protection

Material	Clamp	1.4571 / 316 L
	Clamp with slot	1.4571 / 316 L
	Clamping ring	A2

Above steel qualities are available ex stock. Other steel qualities such as 316L and other dimensions are available upon request.

STANDARD-Design for manual welding

DN	d x s	D Ø	A	B	Bar	O-ring	Dimension clamping ring	Part n°
10	13,5 x 1,6	50,4	60	20	30	10,5 x 2,5	1,5	05-16003
12	17,2 x 1,6	50,4	60	20	30	15,0 x 3,0	1,5	05-16004
15	21,3 x 1,6	50,4	60	20	30	18,5 x 3,2	1,5	05-16005
20	26,9 x 1,6	50,4	60	20	30	25,0 x 3,0	1,5	05-16006
25	33,7 x 2,0	50,4	60	20	30	30,0 x 3,0	1,5	05-16007
32	42,4 x 2,0	64,0	74	20	30	39,0 x 3,0	2,0	05-16008
40	48,3 x 2,0	64,0	74	20	30	45,0 x 3,0	2,0	05-16009
50	60,3 x 2,6	77,4	88	20	25	55,0 x 3,0	2,5	05-16010
65	76,0 x 2,6	91,0	100	20	25	72,0 x 4,0	3,0	05-16011
80	88,9 x 2,6	106,0	115	20	25	84,0 x 4,0	3,5	05-16012
100	114,3 x 2,6	155,0	165	20	25	110,0 x 4,0	5,5	05-16013
150	168,3 x 2,6	220,0	235	30	10	163,0 x 4,0	8 ⁵ / ₈	05-16015

ORBITAL-Long design for automatic welding

DN	d x s	D	A	B	Bar	O-ring	Dimension clamping ring	Part n°
10	13,5 x 1,6	50,4	60	30	30	10,5 x 2,5	1,5	05-16027
12	17,2 x 1,6	50,4	60	30	30	15,0 x 3,0	1,5	05-16028
15	21,3 x 1,6	50,4	60	30	30	18,5 x 3,2	1,5	05-16029
20	26,9 x 1,6	50,4	60	30	30	25,0 x 3,0	1,5	05-16030
25	33,7 x 2,0	50,4	60	30	30	30,0 x 3,0	1,5	05-16031
32	42,4 x 2,0	64,0	74	30	30	39,0 x 3,0	2,0	05-16032
40	48,3 x 2,0	64,0	74	30	30	45,0 x 3,0	2,0	05-16033
50	60,3 x 2,6	77,4	88	30	25	55,0 x 3,0	2,5	05-16034
65	76,0 x 2,6	91,0	100	30	25	72,0 x 4,0	3,0	05-16035
80	88,9 x 2,6	106,0	115	30	25	84,0 x 4,0	3,5	05-16036
100	114,3 x 2,6	155,0	165	30	25	110,0 x 4,0	5,5	05-16037
150	168,3 x 2,6	220,0	235	35	10	163,0 x 4,0	8 ⁵ / ₈	05-16038

Dimensions/part numbers are subject to change without notice









ISO

NAUE GmbH

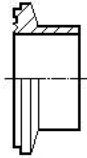
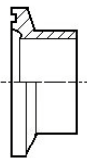
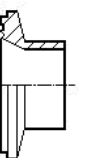
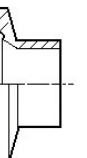
Sondermaschinen - und Filterbau

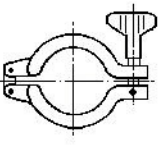
Am Rotböhl 5
64331 Weiterstadt

Tel. 0 61 50 / 97 38 - 0
Fax. 0 61 50 / 70 18

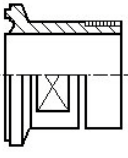
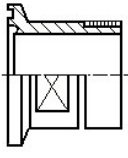
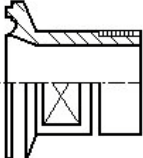
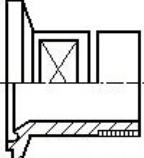
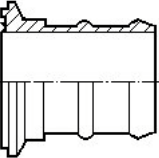
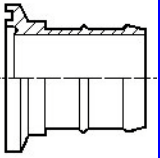
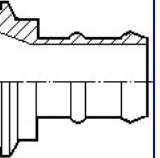
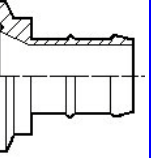
							
DN	Clamp ISO	Clamp with slot ISO	Clamp reduced ISO	Clamp with slot reduced ISO	Blind cap ISO	Blind cap with slot ISO	Clamping ring ISO
10	05-16128	05-16103	05-16228	05-16253	05-16303	05-16353	05-00001
12	05-16129	05-16104	05-16229	05-16254	05-16304	05-16354	05-00001
15	05-16130	05-16105	05-16230	05-16255	05-16305	05-16355	05-00001
20	05-16131	05-16106	05-16231	05-16256	05-16306	05-16356	05-00001
25	05-16132	05-16107	05-16232	05-16257	05-16307	05-16357	05-00001
32	05-16133	05-16108	05-16233	05-16258	05-16308	05-16358	05-00002
40	05-16134	05-16109	05-16234	05-16259	05-16309	05-16359	05-00002
50	05-16135	05-16110	05-16235	05-16260	05-16310	05-16360	05-00003
65	05-16136	05-16111	05-16236	05-16261	05-16311	05-16361	05-00004
80	05-16137	05-16112	05-16237	05-16262	05-16312	05-16362	05-00005
100	05-16138	05-16113	05-16238	05-16263	05-16313	05-16363	05-00006
150	05-16140	05-16115	05-16240	05-16265	05-16315	05-16365	05-00006
							
DN	Female clamp adapter ISO	Female clamp adapter with slot ISO	Female clamp adapter reduced ISO	Female clamp adapter with slot reduced ISO		Male clamp adapter ISO	Male clamp adapter with slot ISO
10	05-16378	05-16403	05-16428	05-16453		05-16828	05-16853
12	05-16379	05-16404	05-16429	05-16454		05-16829	05-16854
15	05-16380	05-16405	05-16430	05-16455		05-16830	05-16855
20	05-16381	05-16406	05-16431	05-16456		05-16831	05-16856
25	05-16382	05-16407	05-16432	05-16457		05-16832	05-16857
32	05-16383	05-16408	05-16433	05-16458		05-16833	05-16858
40	05-16384	05-16409	05-16434	05-16459		05-16834	05-16859
50	05-16385	05-16410	05-16435	05-16460		05-16835	05-16860
65	05-16386	05-16411	05-16436	05-16461		05-16836	05-16861
80	05-16387	05-16412	05-16437	05-16462		05-16837	05-16862
100	05-16388	05-16413	05-16438	05-16463		05-16838	05-16863
150	05-16390	05-16415	05-16440	05-16465		05-16840	05-16865
							
DN	Male clamp adapter ISO	Male clamp adapter with slot ISO	Clamp hose fitting ISO	Clamp hose fitting with slot ISO	Clamp hose fitting reduced ISO	Clamp hose fitting reduced with slot ISO	
10	05-16878	05-16903	05-16728	05-16703	05-16803	05-16778	
12	05-16879	05-16904	05-16729	05-16704	05-16804	05-16779	
15	05-16880	05-16905	05-16730	05-16705	05-16805	05-16780	
20	05-16881	05-16906	05-16731	05-16706	05-16806	05-16781	
25	05-16882	05-16907	05-16732	05-16707	05-16807	05-16782	
32	05-16883	05-16908	05-16733	05-16708	05-16808	05-16783	
40	05-16884	05-16909	05-16734	05-16709	05-16809	05-16784	
50	05-16885	05-16910	05-16735	05-16710	05-16810	05-16785	
65	05-16886	05-16911	05-16736	05-16711	05-16811	05-16786	
80	05-16887	05-16912	05-16737	05-16712	05-16812	05-16787	
100	05-16888	05-16913	05-16738	05-16713	05-16813	05-16788	
150	05-16890	05-16915	05-16740	05-16715	05-16815	05-16790	

Dimensions/part numbers are subject to change without notice