



ISO

NAUE GmbH

Sondermaschinen - und Filterbau

Am Rotböll 5
64331 Weiterstadt
www.naue.de

Tel. 0 61 50 / 97 38 - 0
Fax. 0 61 50 / 70 18
Info@naue.de

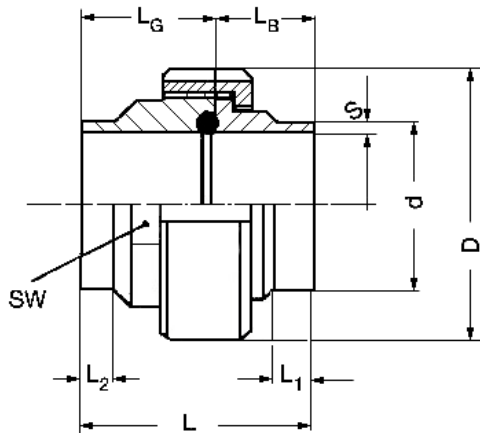

Union for sterile applications

Material	Male part	1.4404 / 316 L
	Liner	1.4404 / 316 L
	Nut	1.4301 / 304

Above steel qualities are available ex stock. Other steel qualities such as 316L and other dimensions are available upon request.

STANDARD-Design for manual welding

Metric thread											Round thread	
DN	d ISO	D	L	L ₁	L ₂	I _B	L _G	SW	O-ring	Part n°	D	Part n°
4	6,0 x 1,0		33	6	5	15	18		4,0 x 2,0	05-10999		-----
6	8,0 x 1,0	SW 19	33	6	5	15	18	10	6,0 x 2,5	05-11000		05-13000
8	10,2 x 1,0	SW 24	33	6	5	15	18	13	8,0 x 2,5	05-11001		05-13001
10	13,5 x 1,6	SW 27	33	6	5	15	18	17	10,5 x 2,5	05-11002		05-13002
12	17,2 x 1,6	SW 30	36	6	5	16	20	19	15,0 x 3,0	05-11003		05-13003
15	21,3 x 1,6	SW 36	36	6	5	16	20	22	18,5 x 3,0	05-11004		05-13004
20	26,9 x 1,6	Ø 48	40	12	6	18	22		25,0 x 3,0	05-11005		05-13005
25	33,7 x 2,0	Ø 52	42	12	6	19	23		30,0 x 3,0	05-11006		05-13006
32	42,4 x 2,0	Ø 60	45	12	6	21	24		39,0 x 3,0	05-11007		05-13007
40	48,3 x 2,0	Ø 65	45	12	6	21	24		45,0 x 3,0	05-11008		05-13008
50	60,3 x 2,6	Ø 80	47	12	9	22	25		55,0 x 3,0	05-11009		05-13009
65	76,0 x 2,6	Ø 105	70	12	12	31	39		72,0 x 4,0	05-11010		05-13010
80	88,9 x 2,6	Ø 120	70	12	12	31	39		84,0 x 4,0	05-11011		05-13011
100	114,3 x 2,6	Ø 150	70	12	12	31	39		110,0 x 4,0	05-11012		05-13012
150	168,3 x 2,6	Ø 205	70	12	12	31	39		163,0 x 4,0	05-11013		05-13013

ORBITAL-Long design for automatic welding machines

Metric thread											Round thread	
DN	d ISO	D	L	L ₁	L ₂	I _B	L _G	SW	O-ring	Part n°	D	Part n°
4	6,0 x 1,0		53	16	16	25	28		4,0 x 2,0	05-11024		-----
6	8,0 x 1,0	SW 19	53	16	16	25	28	10	6,0 x 2,5	05-11025		05-13025
8	10,2 x 1,0	SW 24	53	16	16	25	28	13	8,0 x 2,5	05-11026		05-13026
10	13,5 x 1,6	SW 27	53	16	16	25	28	17	10,5 x 2,5	05-11027		05-13027
12	17,2 x 1,6	SW 30	53	16	16	25	28	19	15,0 x 3,0	05-11028		05-13028
15	21,3 x 1,6	SW 36	53	16	16	25	28	22	18,5 x 3,0	05-11029		05-13029
20	26,9 x 1,6	Ø 48	53	16	16	25	28		25,0 x 3,0	05-11030		05-13030
25	33,7 x 2,0	Ø 52	55	16	16	25	30		30,0 x 3,0	05-11031		05-13031
32	42,4 x 2,0	Ø 60	55	16	16	25	30		39,0 x 3,0	05-11032		05-13032
40	48,3 x 2,0	Ø 65	60	16	16	28	32		45,0 x 3,0	05-11033		05-13033
50	60,3 x 2,6	Ø 80	60	16	16	28	32		55,0 x 3,0	05-11034		05-13034
65	76,0 x 2,6	Ø 105	75	16	16	31	44		72,0 x 4,0	05-11035		05-13035
80	88,9 x 2,6	Ø 120	75	16	16	31	44		84,0 x 4,0	05-11036		05-13036
100	114,3 x 2,6	Ø 150	103	30	16	45	58		110,0 x 4,0	05-11037		05-13037
150	168,3 x 2,6	Ø 205	103	30	16	45	58		163,0 x 4,0	05-11038		05-13038









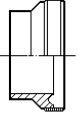
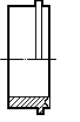
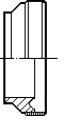

Dimensions/part numbers are subject to change without notice

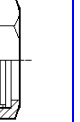
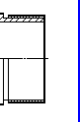
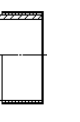
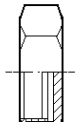
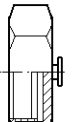

ISO
Metric thread

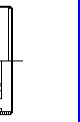
NAUE GmbH

Sondermaschinen - und Filterbau
 Am Rotböhl 5
 64331 Weiterstadt
www.naue.de
 Tel. 0 61 50 / 97 38 – 0
 Fax. 0 61 50 / 70 18
info@naue.de

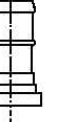
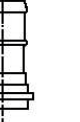
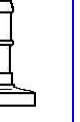
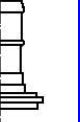
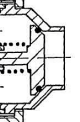
DN	 Male part ISO-orbital	 Liner ISO-orbital	 Male part ISO-standard	 Liner ISO-standard	 Nut ISO	 Nut extended ISO	 Male part threaded outside ISO	 Liner threaded outside ISO
4	05-11099	05-11124	05-11149	05-11174	05/11199	05/11424	05-11849	05-11824
6	05-11100	05-11125	05-11150	05-11175	05/11200	05/11425	05-11850	05-11825
8	05-11101	05-11126	05-11151	05-11176	05/11201	05/11426	05-11851	05-11826
10	05-11102	05-11127	05-11152	05-11177	05/11202	05/11427	05-11852	05-11827
12	05-11103	05-11128	05-11153	05-11178	05/11203	05/11428	05-11853	05-11828
15	05-11104	05-11129	05-11154	05-11179	05/11204	05/11429	05-11854	05-11829
20	05-11105	05-11130	05-11155	05-11180	05/11205	05/11430	05-11855	05-11830
25	05-11106	05-11131	05-11156	05-11181	05/11206	05/11431	05-11856	05-11831
32	05-11107	05-11132	05-11157	05-11182	05/11207	05/11432	05-11857	05-11832
40	05-11108	05-11133	05-11158	05-11183	05/11208	05/11433	05-11858	05-11833
50	05-11109	05-11134	05-11159	05-11184	05/11209	05/11434	05-11859	05-11834
65	05-11110	05-11135	05-11160	05-11185	05/11210	05/11435	05-11860	05-11835
80	05-11111	05-11136	05-11161	05-11186	05/11211	05/11436	05-11861	05-11836
100	05-11112	05-11137	05-11162	05-11187	05/11212	05/11437	05-11862	05-11837
125	05-11113	05-11138	05-11163	05-11188	05/11213	05/11438	05-11863	05-11838
150	05-11114	05-11139	05-11164	05-11189	05/11214	05/11439	05-11864	05-11839
DN	 Blind nut ISO	 Blind nut with button and chain ISO	 Sealing disk for blind nut ISO	 Blind liner massive ISO	 Blind male part ISO	 Liner threaded inside ISO	 Male part threaded inside ISO	 Choke disk ISO
4	05/11224	05/11249	05-11274	05-11299	05-11349	05-11374	05-11399	05-11324
6	05/11225	05/11250	05-11275	05-11300	05-11350	05-11375	05-11400	05-11325
8	05/11226	05/11251	05-11276	05-11301	05-11351	05-11376	05-11401	05-11326
10	05/11227	05/11252	05-11277	05-11302	05-11352	05-11377	05-11402	05-11327
12	05/11228	05/11253	05-11278	05-11303	05-11353	05-11378	05-11403	05-11328
15	05/11229	05/11254	05-11279	05-11304	05-11354	05-11379	05-11404	05-11329
20	05/11230	05/11255	05-11280	05-11305	05-11355	05-11380	05-11405	05-11330
25	05/11231	05/11256	05-11281	05-11306	05-11356	05-11381	05-11406	05-11331
32	05/11232	05/11257	05-11282	05-11307	05-11357	05-11382	05-11407	05-11332
40	05/11233	05/11258	05-11283	05-11308	05-11358	05-11383	05-11408	05-11333
50	05/11234	05/11259	05-11284	05-11309	05-11359	05-11384	05-11409	05-11334
65	05/11235	05/11260	05-11285	05-11310	05-11360	05-11385	05-11410	05-11335
80	05/11236	05/11261	05-11286	05-11311	05-11361	05-11386	05-11411	05-11336
100	05/11237	05/11262	05-11287	05-11312	05-11362	05-11387	05-11412	05-11337
125	05/11238	05/11263	05-11288	05-11313	05-11363	05-11388	05-11413	05-11338
150	05/11239	05/11264	05-11289	05-11314	05-11364	05-11389	05-11414	05-11339
DN	 Bend with male part ISO	 Bend with liner ISO	 Welding bend ISO	 Male part hose fitting ISO	 Liner hose fitting ISO	 Male part hose fitting reduced ISO	 Liner hose fitting reduced ISO	 Nonreturn valve ISO
4	05-11549	05-11624	05-11649	05-11699	05-11724	05-11774	05-11799	05-11574
6	05-11550	05-11625	05-11650	05-11700	05-11725	05-11775	05-11800	05-11575
8	05-11551	05-11626	05-11651	05-11701	05-11726	05-11776	05-11801	05-11576
10	05-11552	05-11627	05-11652	05-11702	05-11727	05-11777	05-11802	05-11577
12	05-11553	05-11628	05-11653	05-11703	05-11728	05-11778	05-11803	05-11578
15	05-11554	05-11629	05-11654	05-11704	05-11729	05-11779	05-11804	05-11579
20	05-11555	05-11630	05-11655	05-11705	05-11730	05-11780	05-11805	05-11580
25	05-11556	05-11631	05-11656	05-11706	05-11731	05-11781	05-11806	05-11581
32	05-11557	05-11632	05-11657	05-11707	05-11732	05-11782	05-11807	05-11582
40	05-11558	05-11633	05-11658	05-11708	05-11733	05-11783	05-11808	05-11583
50	05-11559	05-11634	05-11659	05-11709	05-11734	05-11784	05-11809	05-11584
65	05-11560	05-11635	05-11660	05-11710	05-11735	05-11785	05-11810	05-11585
80	05-11561	05-11636	05-11661	05-11711	05-11736	05-11786	05-11811	05-11586
100	05-11562	05-11637	05-11662	05-11712	05-11737	05-11787	05-11812	05-11587
125	05-11563	05-11638	05-11663	05-11713	05-11738	05-11788	05-11813	05-11588
150	05-11564	05-11639	05-11664	05-11714	05-11739	05-11789	05-11814	05-11589

Dimensions/part numbers are subject to change without notice













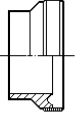
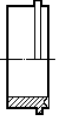
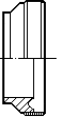

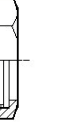
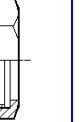

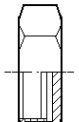
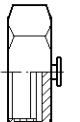

ISO
Round thread

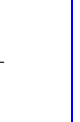
NAUE GmbH

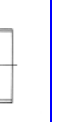
Sondermaschinen - und Filterbau

Am Rotböhl 5
64331 Weiterstadt
www.naue.de

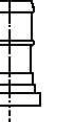
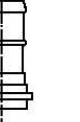
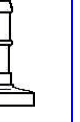
Tel. 0 61 50 / 97 38 – 0
Fax. 0 61 50 / 70 18
info@naue.de

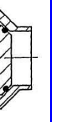
DN	 Male part ISO-orbital	 Liner ISO-orbital	 Male part ISO-standard	 Liner ISO-standard	 Nut ISO	 Nut extended ISO	 Male part threaded outside ISO	 Liner threaded outside ISO
4	05-13099	05-11124	05-13149	05-11174	05/13199	05/13424	05-13849	05-11824
6	05-13100	05-11125	05-13150	05-11175	05/13200	05/13425	05-13850	05-11825
8	05-13101	05-11126	05-13151	05-11176	05/13201	05/13426	05-13851	05-11826
10	05-13102	05-11127	05-13152	05-11177	05/13202	05/13427	05-13852	05-11827
12	05-13103	05-11128	05-13153	05-11178	05/13203	05/13428	05-13853	05-11828
15	05-13104	05-11129	05-13154	05-11179	05/13204	05/13429	05-13854	05-11829
20	05-13105	05-11130	05-13155	05-11180	05/13205	05/13430	05-13855	05-11830
25	05-13106	05-11131	05-13156	05-11181	05/13206	05/13431	05-13856	05-11831
32	05-13107	05-11132	05-13157	05-11182	05/13207	05/13432	05-13857	05-11832
40	05-13108	05-11133	05-13158	05-11183	05/13208	05/13433	05-13858	05-11833
50	05-13109	05-11134	05-13159	05-11184	05/13209	05/13434	05-13859	05-11834
65	05-13110	05-11135	05-13160	05-11185	05/13210	05/13435	05-13860	05-11835
80	05-13111	05-11136	05-13161	05-11186	05/13211	05/13436	05-13861	05-11836
100	05-13112	05-11137	05-13162	05-11187	05/13212	05/13437	05-13862	05-11837
125	05-13113	05-11138	05-13163	05-11188	05/13213	05/13438	05-13863	05-11838
150	05-13114	05-11139	05-13164	05-11189	05/13214	05/13439	05-13864	05-11839
DN	 Blind nut ISO	 Blind nut with button and chain ISO	 Sealing disk for blind nut ISO	 Blind liner massive ISO	 Blind male part ISO	 Liner threaded inside ISO	 Male part threaded inside ISO	 Choke disk ISO
4	05/13224	05/13249	05-11274	05-11299	05-13349	05-11374	05-13399	05-11324
6	05/13225	05/13250	05-11275	05-11300	05-13350	05-11375	05-13400	05-11325
8	05/13226	05/13251	05-11276	05-11301	05-13351	05-11376	05-13401	05-11326
10	05/13227	05/13252	05-11277	05-11302	05-13352	05-11377	05-13402	05-11327
12	05/13228	05/13253	05-11278	05-11303	05-13353	05-11378	05-13403	05-11328
15	05/13229	05/13254	05-11279	05-11304	05-13354	05-11379	05-13404	05-11329
20	05/13230	05/13255	05-11280	05-11305	05-13355	05-11380	05-13405	05-11330
25	05/13231	05/13256	05-11281	05-11306	05-13356	05-11381	05-13406	05-11331
32	05/13232	05/13257	05-11282	05-11307	05-13357	05-11382	05-13407	05-11332
40	05/13233	05/13258	05-11283	05-11308	05-13358	05-11383	05-13408	05-11333
50	05/13234	05/13259	05-11284	05-11309	05-13359	05-11384	05-13409	05-11334
65	05/13235	05/13260	05-11285	05-11310	05-13360	05-11385	05-13410	05-11335
80	05/13236	05/13261	05-11286	05-11311	05-13361	05-11386	05-13411	05-11336
100	05/13237	05/13262	05-11287	05-11312	05-13362	05-11387	05-13412	05-11337
125	05/13238	05/13263	05-11288	05-11313	05-13363	05-11388	05-13413	05-11338
150	05/13239	05/13264	05-11289	05-11314	05-13364	05-11389	05-13414	05-11339
DN	 Bend with male part ISO	 Bend with liner ISO	 Welding bend ISO	 Male part hose fitting ISO	 Liner hose fitting ISO	 Male part hose fitting reduced ISO	 Liner hose fitting reduced ISO	 Nonreturn valve ISO
4	05-13549	05-11624	05-11649	05-13699	05-11724	05-13774	05-11799	05-13574
6	05-13550	05-11625	05-11650	05-13700	05-11725	05-13775	05-11800	05-13575
8	05-13551	05-11626	05-11651	05-13701	05-11726	05-13776	05-11801	05-13576
10	05-13552	05-11627	05-11652	05-13702	05-11727	05-13777	05-11802	05-13577
12	05-13553	05-11628	05-11653	05-13703	05-11728	05-13778	05-11803	05-13578
15	05-13554	05-11629	05-11654	05-13704	05-11729	05-13779	05-11804	05-13579
20	05-13555	05-11630	05-11655	05-13705	05-11730	05-13780	05-11805	05-13580
25	05-13556	05-11631	05-11656	05-13706	05-11731	05-13781	05-11806	05-13581
32	05-13557	05-11632	05-11657	05-13707	05-11732	05-13782	05-11807	05-13582
40	05-13558	05-11633	05-11658	05-13708	05-11733	05-13783	05-11808	05-13583
50	05-13559	05-11634	05-11659	05-13709	05-11734	05-13784	05-11809	05-13584
65	05-13560	05-11635	05-11660	05-13710	05-11735	05-13785	05-11810	05-13585
80	05-13561	05-11636	05-11661	05-13711	05-11736	05-13786	05-11811	05-13586
100	05-13562	05-11637	05-11662	05-13712	05-11737	05-13787	05-11812	05-13587
125	05-13563	05-11638	05-11663	05-13713	05-11738	05-13788	05-11813	05-13588
150	05-13564	05-11639	05-11664	05-13714	05-11739	05-13789	05-11814	05-13589

Dimensions/part numbers are subject to change with out notice



DIN

NAUE GmbH

Sondermaschinen - und Filterbau

Am Rotböll 5
64331 Weiterstadt
www.naue.de

Tel. 0 61 50 / 97 38 - 0
Fax. 0 61 50 / 70 18
Info@naue.de

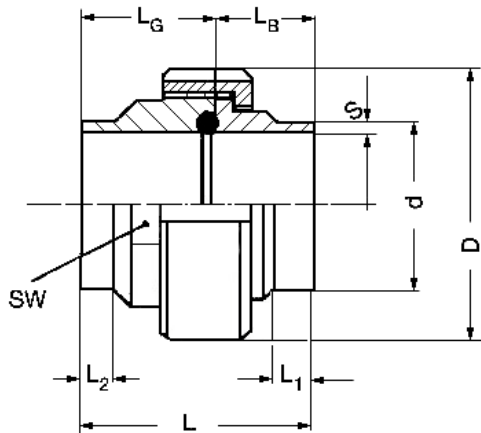

Union for sterile applications

Material	Male part	1.4404 / 316 L
	Liner	1.4404 / 316 L
	Nut	1.4301 / 304

Above steel qualities are available ex stock. Other steel qualities such as 316 L and other dimensions are available upon request

STANDARD-Design for manual welding

Metric thread											Round thread	
DN	d ISO	D	L	L ₁	L ₂	I _B	L _G	SW	O-ring	Part n°	D	Part n°
4	6,0 x 1,0		33	6	5	15	18		4,0 x 2,0	05-11999		-----
6	8,0 x 1,0	SW 19	33	6	5	15	18	10	6,0 x 2,5	05-12000		05-14000
8	10,0 x 1,0	SW 24	33	6	5	15	18	13	8,0 x 2,5	05-12001		05-14001
10	12,0 x 1,0	SW 27	33	6	5	15	18	17	10,5 x 2,5	05-12002		05-14002
15	18,0 x 1,5	SW 32	36	6	5	16	20	19	15,0 x 3,0	05-12004		05-14004
20	22,0 x 1,5	Ø 40	40	12	6	18	22		20,0 x 3,0	05-12005		05-14005
25	28,0 x 1,5	Ø 49	42	12	6	19	23		25,0 x 3,0	05-12006		05-14006
32	34,0 x 1,5	Ø 52	45	12	6	21	24		30,0 x 3,0	05-12007		05-14007
40	40,0 x 1,5	Ø 62	45	12	6	21	24		39,0 x 3,0	05-12008		05-14008
50	52,0 x 1,5	Ø 77	47	12	9	22	25		50,0 x 3,0	05-12009		05-14009
65	70,0 x 2,0	Ø 105	70	12	12	31	39		66,0 x 4,0	05-12010		05-14010
80	85,0 x 2,0	Ø 115	70	12	12	31	39		81,0 x 4,0	05-12011		05-14011
100	104,0 x 2,0	Ø 140	70	12	12	31	39		100,0 x 4,0	05-12012		05-14012
150	154,0 x 2,0	Ø 195	70	12	12	31	39		150,0 x 4,0	05-12013		05-14013

ORBITAL-Long design for automatic welding machines

Metric thread											Round thread	
DN	d ISO	D	L	L ₁	L ₂	I _B	L _G	SW	O-ring	Part n°	D	Part n°
4	6,0 x 1,0		53	16	16	25	28		4,0 x 2,0	05-12024		-----
6	8,0 x 1,0	SW 19	53	16	16	25	28	10	6,0 x 2,5	05-12025		05-14025
8	10,0 x 1,0	SW 24	53	16	16	25	28	13	8,0 x 2,5	05-12026		05-14026
10	12,0 x 1,0	SW 27	53	16	16	25	28	17	10,5 x 2,5	05-12027		05-14027
15	18,0 x 1,5	SW 32	53	16	16	25	28	19	15,0 x 3,0	05-12029		05-14029
20	22,0 x 1,5	Ø 40	53	16	16	25	28		20,0 x 3,0	05-12030		05-14030
25	28,0 x 1,5	Ø 49	55	16	16	25	30		25,0 x 3,0	05-12031		05-14031
32	34,0 x 1,5	Ø 52	55	16	16	25	30		30,0 x 3,0	05-12032		05-14032
40	40,0 x 1,5	Ø 62	60	16	16	28	32		39,0 x 3,0	05-12033		05-14033
50	52,0 x 1,5	Ø 77	60	16	16	28	32		50,0 x 3,0	05-12034		05-14034
65	70,0 x 2,0	Ø 105	75	16	16	31	44		66,0 x 4,0	05-12035		05-14035
80	85,0 x 2,0	Ø 115	75	16	16	31	44		81,0 x 4,0	05-12036		05-14036
100	104,0 x 2,0	Ø 140	103	30	16	45	58		100,0 x 4,0	05-12037		05-14037
150	154,0 x 2,0	Ø 195	103	30	16	45	58		150,0 x 4,0	05-12038		05-14038

Dimensions/part numbers are subject to change without notice











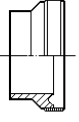
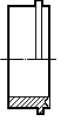
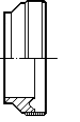

DIN
Metric thread

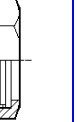
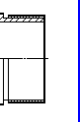
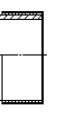
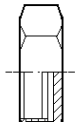
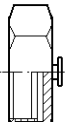
NAUE GmbH

Sondermaschinen - und Filterbau

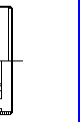
Am Rotböhl 5
64331 Weiterstadt
www.naue.de

Tel. 0 61 50 / 97 38 – 0
Fax. 0 61 50 / 70 18
info@naue.de

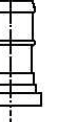
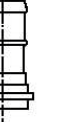
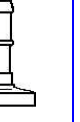
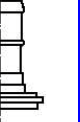
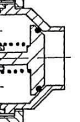
DN	 Male part DIN-orbital	 Liner DIN-orbital	 Male part DIN-standard	 Liner DIN-standard	 Nut DIN	 Nut extended DIN	 Male part threaded outside DIN	 Liner threaded outside DIN
4	05-12099	05-12124	05-12149	05-12174	05/11199	05/11424	05-12849	05-12824
6	05-12100	05-12125	05-12150	05-12175	05/11200	05/11425	05-12850	05-12825
8	05-12101	05-12126	05-12151	05-12176	05/11201	05/11426	05-12851	05-12826
10	05-12102	05-12127	05-12152	05-12177	05/11202	05/11427	05-12852	05-12827
15	05-12104	05-12129	05-12154	05-12179	05/11203	05/11428	05-12854	05-12829
20	05-12105	05-12130	05-12155	05-12180	05/12205	05/12430	05-12855	05-12830
25	05-12106	05-12131	05-12156	05-12181	05/12206	05/12431	05-12856	05-12831
32	05-12107	05-12132	05-12157	05-12182	05/11206	05/11431	05-12857	05-12832
40	05-12108	05-12133	05-12158	05-12183	05/11207	05/11432	05-12858	05-12833
50	05-12109	05-12134	05-12159	05-12184	05/12209	05/12434	05-12859	05-12834
65	05-12110	05-12135	05-12160	05-12185	05/11210	05/11435	05-12860	05-12835
80	05-12111	05-12136	05-12161	05-12186	05/11211	05/11436	05-12861	05-12836
100	05-12112	05-12137	05-12162	05-12187	05/12212	05/12437	05-12862	05-12837
125	05-12113	05-12138	05-12163	05-12188	05/12213	05/12438	05-12863	05-12838
150	05-12114	05-12139	05-12164	05-12189	05/12214	05/12439	05-12864	05-12839
DN	 Blind nut DIN	 Blind nut with button and chain DIN	 Sealing disk for blind nut DIN	 Blind liner massive DIN	 Blind male part DIN	 Liner threaded inside DIN	 Male part threaded inside DIN	 Choke disk DIN
4	05/11224	05/11249	05-11274	05-12299	05-12349	05-12374	05-12399	05-12324
6	05/11225	05/11250	05-11275	05-12300	05-12350	05-12375	05-12400	05-12325
8	05/11226	05/11251	05-11276	05-12301	05-12351	05-12376	05-12401	05-12326
10	05/11227	05/11252	05-11277	05-12302	05-12352	05-12377	05-12402	05-12327
15	05/11228	05/11253	05-11278	05-12304	05-12354	05-12379	05-12404	05-12329
20	05/12230	05/12255	05-12280	05-12305	05-12355	05-12380	05-12405	05-12330
25	05/12231	05/12256	05-12281	05-12306	05-12356	05-12381	05-12406	05-12331
32	05/11231	05/11256	05-11281	05-12307	05-12357	05-12382	05-12407	05-12332
40	05/11232	05/11257	05-11282	05-12308	05-12358	05-12383	05-12408	05-12333
50	05/12234	05/12259	05-12284	05-12309	05-12359	05-12384	05-12409	05-12334
65	05/11235	05/11260	05-11285	05-12310	05-12360	05-12385	05-12410	05-12335
80	05/11236	05/11261	05-11286	05-12311	05-12361	05-12386	05-12411	05-12336
100	05/12237	05/12262	05-12287	05-12312	05-12362	05-12387	05-12412	05-12337
125	05/12238	05/12263	05-12288	05-12313	05-12363	05-12388	05-12413	05-12338
150	05/12239	05/12264	05-12289	05-12314	05-12364	05-12389	05-12414	05-12339
DN	 Bend with male part DIN	 Bend with liner DIN	 Welding bend DIN	 Male part hose fitting DIN	 Liner hose fitting DIN	 Male part hose fitting reduced DIN	 Liner hose fitting reduced DIN	 Nonreturn valve DIN
4	05-12549	05-12624	05-12649	05-12699	05-12724	05-12774	05-12799	05-12574
6	05-12550	05-12625	05-12650	05-12700	05-12725	05-12775	05-12800	05-12575
8	05-12551	05-12626	05-12651	05-12701	05-12726	05-12776	05-12801	05-12576
10	05-12552	05-12627	05-12652	05-12702	05-12727	05-12777	05-12802	05-12577
15	05-12554	05-12629	05-12654	05-12074	05-12729	05-12779	05-12804	05-12579
20	05-12555	05-12630	05-12655	05-12705	05-12730	05-12780	05-12805	05-12580
25	05-12556	05-12631	05-12656	05-12706	05-12731	05-12781	05-12806	05-12581
32	05-12557	05-12632	05-12657	05-12707	05-12732	05-12782	05-12807	05-12582
40	05-12558	05-12633	05-12658	05-12708	05-12733	05-12783	05-12808	05-12583
50	05-12559	05-12634	05-12659	05-12709	05-12734	05-12784	05-12809	05-12584
65	05-12560	05-12635	05-12660	05-12710	05-12735	05-12785	05-12810	05-12585
80	05-12561	05-12636	05-12661	05-12711	05-12736	05-12786	05-12811	05-12586
100	05-12562	05-12637	05-12662	05-12712	05-12737	05-12787	05-12812	05-12587
125	05-12563	05-12638	05-12663	05-12713	05-12738	05-12788	05-12813	05-12588
150	05-12564	05-12639	05-12664	05-12714	05-12739	05-12789	05-12814	05-12589











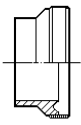
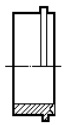

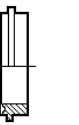
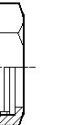
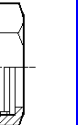

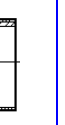
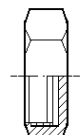
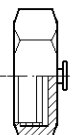
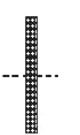
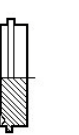
Dimensions/part numbers are subject to change without notice

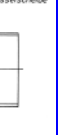

DIN
Round thread

NAUE GmbH

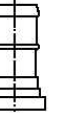
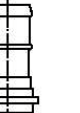
Sondermaschinen - und Filterbau
 Am Rotböhl 5
 64331 Weiterstadt
www.naue.de
 Tel. 0 61 50 / 97 38 – 0
 Fax. 0 61 50 / 70 18
 info@naue.de

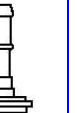
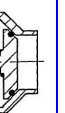
DN	 Male part DIN-orbital	 Liner DIN-orbital	 Male part DIN-standard	 Liner DIN-standard	 Nut DIN	 Nut extended DIN	 Male part threaded outside DIN	 Liner threaded outside DIN
6	05-14100	05-12125	05-14150	05-12175	05/13200	05/13425	05-14850	05-12825
8	05-14101	05-12126	05-14151	05-12176	05/13201	05/13426	05-14851	05-12826
10	05-14102	05-12127	05-14152	05-12177	05/13202	05/13427	05-14852	05-12827
15	05-14104	05-12129	05-14154	05-12179	05/13203	05/13428	05-14854	05-12829
20	05-14105	05-12130	05-14155	05-12180	05/14205	05/14430	05-14855	05-12830
25	05-14106	05-12131	05-14156	05-12181	05/14206	05/14431	05-14856	05-12831
32	05-14107	05-12132	05-14157	05-12182	05/13206	05/13431	05-14857	05-12832
40	05-14108	05-12133	05-14158	05-12183	05/13207	05/13432	05-14858	05-12833
50	05-14109	05-12134	05-14159	05-12184	05/14209	05/14434	05-14859	05-12834
65	05-14110	05-12135	05-14160	05-12185	05/13210	05/13435	05-14860	05-12835
80	05-14111	05-12136	05-14161	05-12186	05/13211	05/13436	05-14861	05-12836
100	05-14112	05-12137	05-14162	05-12187	05/14212	05/14437	05-14862	05-12837
125	05-14113	05-12138	05-14163	05-12188	05/14213	05/14438	05-14863	05-12838
150	05-14114	05-12139	05-14164	05-12189	05/14214	05/14439	05-14864	05-12839
DN	 Blind nut DIN	 Blind nut with button and chain DIN	 Sealing disk for blind nut DIN	 Blind liner massive DIN	 Blind male part DIN	 Liner threaded inside DIN	 Male part threaded inside DIN	 Choke disk DIN
6	05/13225	05/13250	05-11275	05-12300	05-14350	05-12375	05-14400	05-12325
8	05/13226	05/13251	05-11276	05-12301	05-14351	05-12376	05-14401	05-12326
10	05/13227	05/13252	05-11277	05-12302	05-14352	05-12377	05-14402	05-12327
15	05/13228	05/13253	05-11278	05-12304	05-14354	05-12379	05-14404	05-12329
20	05/14230	05/14255	05-12280	05-12305	05-14355	05-12380	05-14405	05-12330
25	05/14231	05/14256	05-12281	05-12306	05-14356	05-12381	05-14406	05-12331
32	05/13231	05/13256	05-11281	05-12307	05-14357	05-12382	05-14407	05-12332
40	05/13232	05/13257	05-11282	05-12308	05-14358	05-12383	05-14408	05-12333
50	05/14234	05/14259	05-12284	05-12309	05-14359	05-12384	05-14409	05-12334
65	05/13235	05/13260	05-11285	05-12310	05-14360	05-12385	05-14410	05-12335
80	05/13236	05/13261	05-11286	05-12311	05-14361	05-12386	05-14411	05-12336
100	05/14237	05/14262	05-12287	05-12312	05-14362	05-12387	05-14412	05-12337
125	05/14238	05/14263	05-12288	05-12313	05-14363	05-12388	05-14413	05-12338
150	05/14239	05/14264	05-12289	05-12314	05-14364	05-12389	05-14414	05-12339
DN	 Bend with male part DIN	 Bend with liner DIN	 Welding bend DIN	 Male part hose fitting DIN	 Liner hose fitting DIN	 Male part hose fitting reduced DIN	 Liner hose fitting reduced DIN	 Nonreturn valve DIN
6	05-14550	05-12625	05-12650	05-14700	05-12725	05-14775	05-12800	05-14575
8	05-14551	05-12626	05-12651	05-14701	05-12726	05-14776	05-12801	05-14576
10	05-14552	05-12627	05-12652	05-14702	05-12727	05-14777	05-12802	05-14577
15	05-14554	05-12629	05-12654	05-14074	05-12729	05-14779	05-12804	05-14579
20	05-14555	05-12630	05-12655	05-14705	05-12730	05-14780	05-12805	05-14580
25	05-14556	05-12631	05-12656	05-14706	05-12731	05-14781	05-12806	05-14581
32	05-14557	05-12632	05-12657	05-14707	05-12732	05-14782	05-12807	05-14582
40	05-14558	05-12633	05-12658	05-14708	05-12733	05-14783	05-12808	05-14583
50	05-14559	05-12634	05-12659	05-14709	05-12734	05-14784	05-12809	05-14584
65	05-14560	05-12635	05-12660	05-14710	05-12735	05-14785	05-12810	05-14585
80	05-14561	05-12636	05-12661	05-14711	05-12736	05-14786	05-12811	05-14586
100	05-14562	05-12637	05-12662	05-14712	05-12737	05-14787	05-12812	05-14587
125	05-14563	05-12638	05-12663	05-14713	05-12738	05-14788	05-12813	05-14588
150	05-14564	05-12639	05-12664	05-14714	05-12739	05-14789	05-12814	05-14589

Dimensions/part numbers are subject to change without notice



DIN
line 2

NAUE GmbH

Sondermaschinen - und Filterbau

Am Rotböhl 5
64331 Weiterstadt
www.naue.de

Tel. 0 61 50 / 97 38 - 0
Fax. 0 61 50 / 70 18
Info@naue.de

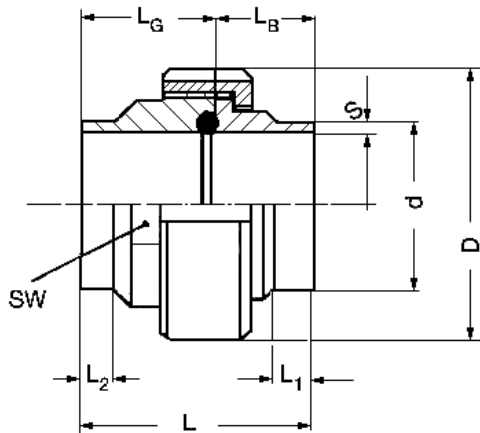

Union for sterile applications

Material	Male part	1.4404 / 316 L
	Liner	1.4404 / 316 L
	Nut	1.4301 / 304

Above steel qualities are available ex stock. Other steel qualities such as 316L and other dimensions are available upon request

STANDARD-Design for manual welding

Metric thread											Round thread	
DN	d ISO	D	L	L ₁	L ₂	I _B	L _G	SW	O-ring	Part n°	D	Part n°
10	13,0 x 1,5	SW 27	33	6	5	15	18		10,5 x 2,5	05-22002		05-23002
15	19,0 x 1,5	SW 32	36	6	5	16	20		16,0 x 3,0	05-22004		05-23004
20	23,0 x 1,5	Ø 40	40	12	6	18	22		20,0 x 3,0	05-22005		05-23005
25	29,0 x 1,5	Ø 49	42	12	6	19	23		27,0 x 3,0	05-22006		05-23006
32	35,0 x 1,5	Ø 52	45	12	6	21	24		33,0 x 3,0	05-22007		05-23007
40	41,0 x 1,5	Ø 62	45	12	6	21	24		39,0 x 3,0	05-22008		05-23008
50	53,0 x 1,5	Ø 77	47	12	9	22	25		50,0 x 3,0	05-22009		05-23009

ORBITAL-Long design for automatic welding machines

Metric thread											Round thread	
DN	d ISO	D	L	L ₁	L ₂	I _B	L _G	SW	O-ring	Part n°	D	Part n°
10	13,0 x 1,5	SW 27	53	16	16	25	28		10,5 x 2,5	05-22027		05-23027
15	19,0 x 1,5	SW 32	53	16	16	25	28		16,0 x 3,0	05-22029		05-23029
20	23,0 x 1,5	Ø 40	53	16	16	25	28		20,0 x 3,0	05-22030		05-23030
25	29,0 x 1,5	Ø 49	55	16	16	25	30		27,0 x 3,0	05-22031		05-23031
32	35,0 x 1,5	Ø 52	55	16	16	25	30		33,0 x 3,0	05-22032		05-23032
40	41,0 x 1,5	Ø 62	60	16	16	28	32		39,0 x 3,0	05-22033		05-23033
50	53,0 x 1,5	Ø 77	60	16	16	28	32		50,0 x 3,0	05-22034		05-23034









Dimensions/part numbers are subject to change without notice

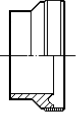
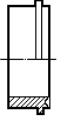
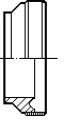

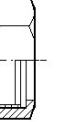
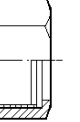
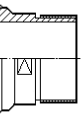
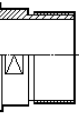
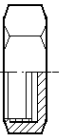
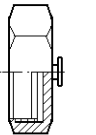
DIN line 2
Metric thread

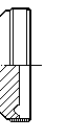
NAUE GmbH

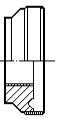
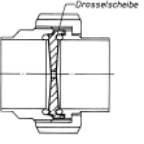
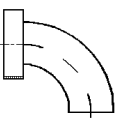
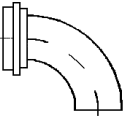
Sondermaschinen - und Filterbau
 Am Rotböhl 5
 64331 Weiterstadt
www.naue.de
 Tel. 0 61 50 / 97 38 – 0
 Fax. 0 61 50 / 70 18
 info@naue.de

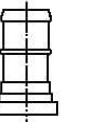
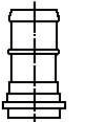
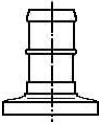
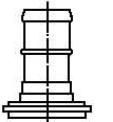
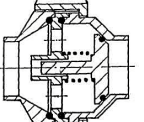
DN	 Male part DIN 2-orbital	 Liner DIN 2-orbital	 Male part DIN 2-standard	 Liner DIN 2-standard	 Nut DIN 2	 Nut extended DIN 2	 Male part threaded outside DIN 2	 Liner threaded outside DIN 2
10	05-22102	05-22127	05-22152	05-22177	05/11202	05/11427	05-22852	05-22827
15	05-22104	05-22129	05-22154	05-22179	05/11203	05/11428	05-22854	05-22829
20	05-22105	05-22130	05-22155	05-22180	05/12205	05/12430	05-22855	05-22830
25	05-22106	05-22131	05-22156	05-22181	05/12206	05/12431	05-22856	05-22831
32	05-22107	05-22132	05-22157	05-22182	05/22206	05/22431	05-22857	05-22832
40	05-22108	05-22133	05-22158	05-22183	05/11207	05/11432	05-22858	05-22833
50	05-22109	05-22134	05-22159	05-22184	05/12209	05/12434	05-22859	05-22834
DN	 Blind nut DIN 2	 Blind nut with button and chain DIN 2	 Sealing disk for blind nut DIN 2	 Blind liner massive DIN 2	 Blind male part DIN 2	 Liner threaded inside DIN 2	 Male part threaded inside DIN 2	 Choke disk DIN 2
10	05/11227	05/11252	05-22277	05-22302	05-22352	05-22377	05-22402	05-22327
15	05/11228	05/11253	05-22278	05-22304	05-22354	05-22379	05-22404	05-22329
20	05/12230	05/12255	05-22280	05-22305	05-22355	05-22380	05-22405	05-22330
25	05/12231	05/12256	05-22281	05-22306	05-22356	05-22381	05-22406	05-22331
32	05/22231	05/22256	05-22281	05-22307	05-22357	05-22382	05-22407	05-22332
40	05/11232	05/11257	05-22282	05-22308	05-22358	05-22383	05-22408	05-22333
50	05/12234	05/12259	05-22284	05-22309	05-22359	05-22384	05-22409	05-22334
DN	 Bend with male part DIN 2	 Bend with liner DIN 2	 Welding bend DIN 2	 Male part hose fitting DIN 2	 Liner hose fitting DIN 2	 Male part hose fitting reduced DIN 2	 Liner hose fitting reduced DIN 2	 Nonreturn valve DIN 2
10	05-22552	05-22627	05-22652	05-22702	05-22727	05-22777	05-22802	05-22577
15	05-22554	05-22629	05-22654	05-22074	05-22729	05-22779	05-22804	05-22579
20	05-22555	05-22630	05-22655	05-22705	05-22730	05-22780	05-22805	05-22580
25	05-22556	05-22631	05-22656	05-22706	05-22731	05-22781	05-22806	05-22581
32	05-22557	05-22632	05-22657	05-22707	05-22732	05-22782	05-22807	05-22582
40	05-22558	05-22633	05-22658	05-22708	05-22733	05-22783	05-22808	05-22583
50	05-22559	05-22634	05-22659	05-22709	05-22734	05-22784	05-22809	05-22584











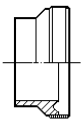
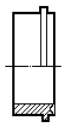
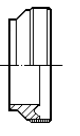
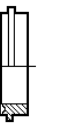
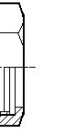
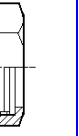

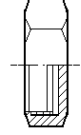
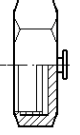
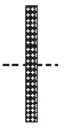
Dimensions/part numbers are subject to change without notice



DIN line 2
Round thread

NAUE GmbH

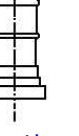
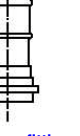
Sondermaschinen - und Filterbau
 Am Rotböhl 5
 64331 Weiterstadt
www.naue.de
 Tel. 0 61 50 / 97 38 – 0
 Fax. 0 61 50 / 70 18
 info@naue.de

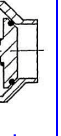
DN	 Male part DIN 2-orbital	 Liner DIN 2-orbital	 Male part DIN 2-standard	 Liner DIN 2-standard	 Nut DIN 2	 Nut extended DIN 2	 Male part threaded outside DIN 2	 Liner threaded outside DIN 2
10	05-23102	05-22127	05-23152	05-22177	05/13202	05/13427	05-23852	05-22827
15	05-23104	05-22129	05-23154	05-22179	05/13203	05/13428	05-23854	05-22829
20	05-23105	05-22130	05-23155	05-22180	05/14205	05/14430	05-23855	05-22830
25	05-23106	05-22131	05-23156	05-22181	05/14206	05/14431	05-23856	05-22831
32	05-23107	05-22132	05-23157	05-22182	05/23206	05/23431	05-23857	05-22832
40	05-23108	05-22133	05-23158	05-22183	05/13207	05/13432	05-23858	05-22833
50	05-23109	05-22134	05-23159	05-22184	05/14209	05/14434	05-23859	05-22834
DN	 Blind nut DIN 2	 Blind nut with button and chain DIN 2	 Sealing disk for blind nut DIN 2	 Blind liner massive DIN 2	 Blind male part DIN 2	 Liner threaded inside DIN 2	 Male part threaded inside DIN 2	 Choke disk DIN 2
10	05/13227	05/13252	05-22277	05-22302	05-23352	05-22377	05-23402	05-22327
15	05/13228	05/13253	05-22278	05-22304	05-23354	05-22379	05-23404	05-22329
20	05/14230	05/14255	05-22280	05-22305	05-23355	05-22380	05-23405	05-22330
25	05/14231	05/14256	05-22281	05-22306	05-23356	05-22381	05-23406	05-22331
32	05/23231	05/23256	05-22281	05-22307	05-23357	05-22382	05-23407	05-22332
40	05/13232	05/13257	05-22282	05-22308	05-23358	05-22383	05-23408	05-22333
50	05/14234	05/14259	05-22284	05-22309	05-23359	05-22384	05-23409	05-22334
DN	 Bend with male part DIN 2	 Bend with liner DIN 2	 Welding bend DIN 2	 Male part hose fitting DIN 2	 Liner hose fitting DIN 2	 Male part hose fitting reduced DIN 2	 Liner hose fitting reduced DIN 2	 Nonreturn valve DIN 2
10	05-23552	05-22627	05-22652	05-23702	05-22727	05-23777	05-22802	05-23577
15	05-23554	05-22629	05-22654	05-23074	05-22729	05-23779	05-22804	05-23579
20	05-23555	05-22630	05-22655	05-23705	05-22730	05-23780	05-22805	05-23580
25	05-23556	05-22631	05-22656	05-23706	05-22731	05-23781	05-22806	05-23581
32	05-23557	05-22632	05-22657	05-23707	05-22732	05-23782	05-22807	05-23582
40	05-23558	05-22633	05-22658	05-23708	05-22733	05-23783	05-22808	05-23583
50	05-23559	05-22634	05-22659	05-23709	05-22734	05-23784	05-22809	05-23584

Dimensions/part numbers are subject to change without notice



US
o.D.Tubing

NAUE GmbH

Sondermaschinen - und Filterbau

Am Rotböhl 5
64331 Weiterstadt
www.naue.de

Tel. 0 61 50 / 97 38 - 0
Fax. 0 61 50 / 70 18
Info@naue.de

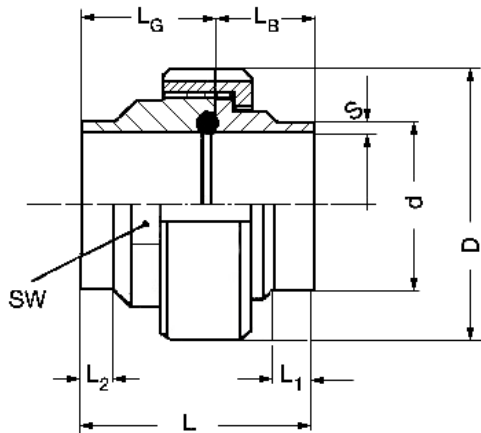

Union for sterile applications

Material	Male part	1.4404 / 316 L
	Liner	1.4404 / 316 L
	Nut	1.4301 / 304

Above steel qualities are available ex stock. Other steel qualities such as 316L and other dimensions are available upon request.

STANDARD-Design for manual welding

Metric thread											Round thread	
DN	d ISO	D	L	L ₁	L ₂	I _B	L _G	SW	O-ring	Part n°	D	Part n°
1/4	6,35 x 1,22	SW 17	33	6	5	15	18	8	4,0 x 2,0	05-15001		05-19001
3/8	9,53 x 1,22	SW 24	33	6	5	15	18	13	7,5 x 2,5	05-15003		05-19003
1/2	12,70 x 1,65	SW 27	33	6	5	15	18	17	10,0 x 2,5	05-15005		05-19005
3/4	19,05 x 1,65	SW 36	36	6	5	16	20	22	16,3 x 3,0	05-15007		05-19007
1	25,40 x 1,65	Ø 48	40	6	5	18	22		22,0 x 3,0	05-15009		05-19009
1 1/2	38,10 x 1,65	Ø 62	45	12	6	21	24		36,0 x 3,0	05-15011		05-19011
2	50,80 x 1,65	Ø 76	47	12	6	22	25		48,0 x 3,0	05-15013		05-19013
2 1/2	63,50 x 1,65	Ø 95	70	12	12	31	39		61,0 x 4,0	05-15015		05-19015
3	76,20 x 1,65	Ø 105	70	12	12	31	39		74,0 x 4,0	05-15017		05-19017
4	101,60 x 2,10	Ø 140	70	12	12	31	39		100,0 x 5,0	05-15019		05-19019

ORBITAL-Long design for automatic welding machines

Metric thread											Round thread	
DN	d ISO	D	L	L ₁	L ₂	I _B	L _G	SW	O-ring	Part n°	D	Part n°
1/4	6,35 x 1,22	SW 17	33	16	16	25	28	8	4,0 x 2,0	05-15025		05-19025
3/8	9,53 x 1,22	SW 24	33	16	16	25	28	13	7,5 x 2,5	05-15027		05-19027
1/2	12,70 x 1,65	SW 27	33	16	16	25	28	17	10,0 x 2,5	05-15029		05-19029
3/4	19,05 x 1,65	SW 36	36	16	16	25	28	22	16,3 x 3,0	05-15031		05-19031
1	25,40 x 1,65	Ø 48	40	16	16	25	28		22,0 x 3,0	05-15033		05-19033
1 1/2	38,10 x 1,65	Ø 62	45	16	16	26	32		36,0 x 3,0	05-15035		05-19035
2	50,80 x 1,65	Ø 76	47	16	16	26	32		48,0 x 3,0	05-15037		05-19037
2 1/2	63,50 x 1,65	Ø 95	70	16	16	31	44		61,0 x 4,0	05-15039		05-19039
3	76,20 x 1,65	Ø 105	70	16	16	31	44		74,0 x 4,0	05-15041		05-19041
4	101,60 x 2,10	Ø 140	70	16	16	45	58		100,0 x 5,0	05-15043		05-19043

Dimensions/part numbers are subject to change without notice

