



DIN

# NAUE GmbH

Sondermaschinen - und Filterbau

Am Rotböhl 5  
64331 Weiterstadt

Tel. 0 61 50 / 97 38 - 0  
Fax. 0 61 50 / 70 18

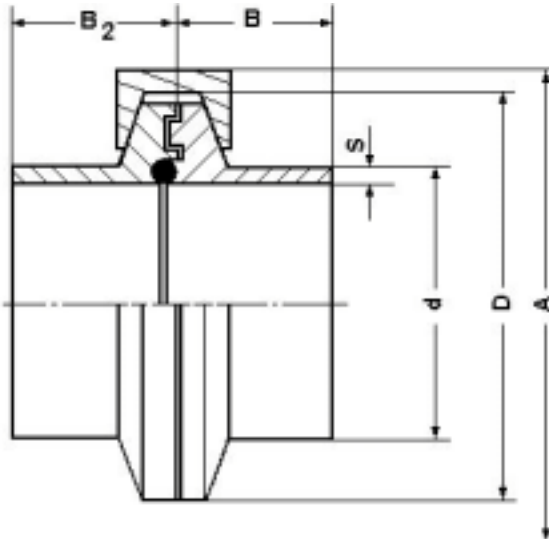

## Steril-Klemmring mit zweiseitigem Dichtflächenschutz

Material	Bundstutzen	1.4571 / 316 L
	Nutstutzen	1.4571 / 316 L
	Klammer	A2
Andere Werkstoffe und Abmessungen auf Anfrage		

### STANDARD-SCHWEISS-AUSFÜHRUNG

DN	d x s	D Ø	A	B	Bar	O-Ring	Klammer Größe	Bestell-Nr.
10	12,0 x 1,0	50,4	60	20	30	10,5 x 2,5	1,5	05-17003
15	18,0 x 1,5	50,4	60	20	30	15,0 x 3,0	1,5	05-17005
20	22,0 x 1,5	50,4	60	20	30	20,0 x 3,0	1,5	05-17006
25	28,0 x 1,5	50,4	60	20	30	25,0 x 3,0	1,5	05-17007
32	34,0 x 1,5	50,4	60	20	30	30,0 x 3,0	2,0	05-17008
40	40,0 x 1,5	64,0	74	20	30	39,0 x 3,0	2,0	05-17009
50	52,0 x 1,5	77,4	88	20	25	50,0 x 3,0	2,5	05-17010
65	70,0 x 2,0	91,0	100	20	25	66,0 x 4,0	3,0	05-17011
80	85,0 x 2,0	106,0	115	20	25	81,0 x 4,0	3,5	05-17012
100	104,0 x 2,0	119,0	165	20	25	100,0 x 4,0	4,0	05-17013
125	129,0 x 2,0	154,0	166	25	10	125,0 x 4,0	5,5	05-17014
150	154,0 x 2,0	168,0	182	25	10	150,0 x 4,0	6,0	05-17015

### UNIVERSAL-ORBITAL-SCHWEISS-AUSFÜHRUNG

DN	d x s	D Ø	A	B	Bar	O-Ring	Klammer Größe	Bestell-Nr.
10	12,0 x 1,0	50,4	60	30	30	10,5 x 2,5	1,5	05-17027
15	18,0 x 1,5	50,4	60	30	30	15,0 x 3,0	1,5	05-17029
20	22,0 x 1,5	50,4	60	30	30	20,0 x 3,0	1,5	05-17030
25	28,0 x 1,5	50,4	60	30	30	25,0 x 3,0	1,5	05-17031
32	34,0 x 1,5	50,4	60	30	30	30,0 x 3,0	2,0	05-17032
40	40,0 x 1,5	64,0	74	30	30	39,0 x 3,0	2,0	05-17033
50	52,0 x 1,5	77,4	88	30	25	50,0 x 3,0	2,5	05-17034
65	70,0 x 2,0	91,0	100	30	25	66,0 x 4,0	3,0	05-17035
80	85,0 x 2,0	106,0	115	30	25	81,0 x 4,0	3,5	05-17036
100	104,0 x 2,0	119,0	133	30	25	100,0 x 4,0	4,0	05-17037
125	129,0 x 2,0	154,0	166	35	10	125,0 x 4,0	5,5	05-17038
150	154,0 x 2,0	168,0	182	35	10	150,0 x 4,0	6,0	05-17039

Änderungen vorbehalten











DIN

# NAUE GmbH

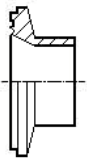
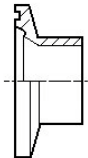
Sondermaschinen - und Filterbau

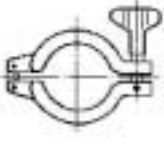
Am Rotböhl 5  
64331 Weiterstadt

Tel. 0 61 50 / 97 38 - 0  
Fax. 0 61 50 / 70 18

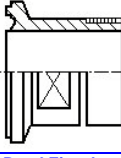
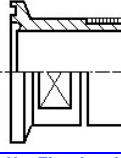
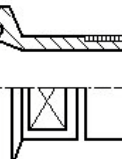
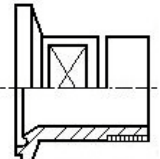
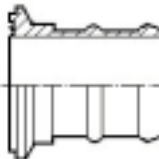
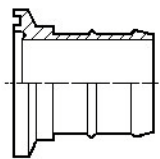
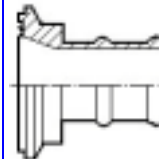
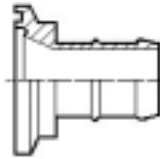
							
DN	Bund Anschweiß Klemmring DIN	Nut Anschweiß Klemmring DIN	Bund Anschweiß Klemmring reduziert DIN	Nut Anschweiß Klemmring reduziert DIN	Bund Blindkappe DIN	Nut Blindkappe DIN	Klemmring Verschluß
10	05-17128	05-17103	05-17228	05-17253	05-17303	05-17353	05-00001
15	05-17130	05-17105	05-17230	05-17255	05-17305	05-17355	05-00001
20	05-17131	05-17106	05-17231	05-17256	05-17306	05-17356	05-00001
25	05-17132	05-17107	05-17232	05-17257	05-17307	05-17357	05-00001
32	05-17133	05-17108	05-17233	05-17258	05-17308	05-17358	05-00002
40	05-17134	05-17109	05-17234	05-17259	05-17309	05-17359	05-00002
50	05-17135	05-17110	05-17235	05-17260	05-17310	05-17360	05-00003
65	05-17136	05-17111	05-17236	05-17261	05-17311	05-17361	05-00004
80	05-17137	05-17112	05-17237	05-17262	05-17312	05-17362	05-00005
100	05-17138	05-17113	05-17238	05-17263	05-17313	05-17363	05-00006
150	05-17140	05-17115	05-17240	05-17265	05-17315	05-17365	05-00006
							
DN	Bund Aufschraub Klemmring DIN	Nut Aufschraub Klemmring DIN	Bund Aufschraub Klemmring reduziert DIN	Nut Aufschraub Klemmring reduziert DIN		Bund Einschraub Klemmring DIN	Nut Einschraub Klemmring DIN
10	05-17378	05-17403	05-17428	05-17453		05-17828	05-17853
15	05-17380	05-17405	05-17430	05-17455		05-17830	05-17855
20	05-17381	05-17406	05-17431	05-17456		05-17831	05-17856
25	05-17382	05-17407	05-17432	05-17457		05-17832	05-17857
32	05-17383	05-17408	05-17433	05-17458		05-17833	05-17858
40	05-17384	05-17409	05-17434	05-17459		05-17834	05-17859
50	05-17385	05-17410	05-17435	05-17460		05-17835	05-17860
65	05-17386	05-17411	05-17436	05-17461		05-17836	05-17861
80	05-17387	05-17412	05-17437	05-17462		05-17837	05-17862
100	05-17388	05-17413	05-17438	05-17463		05-17838	05-17863
150	05-17390	05-17415	05-17440	05-17465		05-17840	05-17865
							
DN	Bund Einschraub Klemmring DIN	Nut Einschraub Klemmring DIN	Bund Schlauch Klemmring DIN	Nut Schlauch Klemmring DIN	Bund Schlauch Klemmring reduziert DIN	Nut Schlauch Klemmring reduziert DIN	
10	05-17878	05-17903	05-17728	05-17703	05-17803	05-17778	
15	05-17880	05-17905	05-17730	05-17705	05-17805	05-17780	
20	05-17881	05-17906	05-17731	05-17706	05-17806	05-17781	
25	05-17882	05-17907	05-17732	05-17707	05-17807	05-17782	
32	05-17883	05-17908	05-17733	05-17708	05-17808	05-17783	
40	05-17884	05-17909	05-17734	05-17709	05-17809	05-17784	
50	05-17885	05-17910	05-17735	05-17710	05-17810	05-17785	
65	05-17886	05-17911	05-17736	05-17711	05-17811	05-17786	
80	05-17887	05-17912	05-17737	05-17712	05-17812	05-17787	
100	05-17888	05-17913	05-17738	05-17713	05-17813	05-17788	
150	05-17890	05-17915	05-17740	05-17715	05-17815	05-17790	

Änderungen vorbehalten